

FOTILE

吸油煙機

使用安裝說明書 | EMS6008/EMS6008-C

請在開始安裝和使用前請仔細閱讀此產品說明書。
請保留此產品說明書，以供今后使用或后續用戶使用。

尊敬的用戶，您好！感謝您選購方太公司為您精心制造的方太系列產品，使用前請通讀本《使用安裝說明書》（以下簡稱說明書），此說明書將有利于您熟悉油煙機安全信息、操作和保養維修等，并讓您享受到全新的下廚樂趣。

請您在使用前務必認真閱讀說明書，并遵從說明書要求進行使用。本說明書的操作說明對於維持產品的良好工作狀況十分重要，若因使用不當造成產品故障，您將失去免費保修的權利，任何直接或間接的免費保修申請將不被本公司各地授權的服務中心所接受。同時我們建議您在質量保修期內及保修期后，如有需要維修時請與方太公司當地授權的服務中心聯系，這對您和我們都是非常重要的。

我們授權的服務中心將為您提供方太公司專業的零部件及技術支持，使您的產品得到優質快捷的維修保障，同時讓您得到最輕鬆細心的服務。

如果您需要服務，您將需要提供產品銘牌上的產品型號和序列號。銘牌位置請參考以下圖示 A 說明。

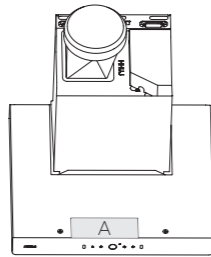

方太澳洲總代理

*地址：127/45 Gilby Road, Mount Waverley
VIC 3149

*電話：(03) 9939 9926

*官網：www.fotile.com.au

*服務郵箱：service@fotile.com.au



澳洲官方微信

目錄





警告和安全說明	2
安裝	2
使用	2
禁止	3
產品信息	5
產品尺寸	5
產品性能	6
使用方法	6
操作說明	6
清潔保養	8
整機表面清潔	8
蝶翼板清潔	8
油網清潔	9
清潔保養周期	9
常見故障的識別和處理	10
常見故障處理表	10
免責說明	10
維修說明	10
LED 燈更換	11
安裝	12
安裝高度	12
攏煙範圍	14
裝箱清單	15
安裝前注意事項	16
外排安裝	18
內循環安裝	24
安裝后的調試	30
爆炸圖	31

產品特征和參數會在無通知情況下隨時更改，并且可能與此說明書略有不同。請訪問我們的官網 www.fotile.com.au，獲取最新信息。

警告和安全說明

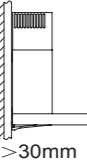

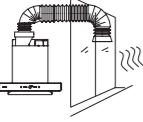
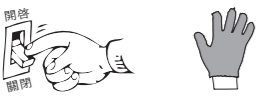
安裝

⚠ 嚴格執行

	由于本吸油煙機的安裝程序比較複雜，且重量較重，應由專業安裝維修人員按照說明書進行安裝。未按說明書要求安裝螺釘或固定裝置可能會導致觸電、脫落、起火等危險。
	安裝吸油煙機的牆壁要有足夠的支撐強度，對於中空牆壁，中空板實心層的厚度必須大于 30mm 以上，如為石膏板牆壁需固定在其背后的木柱上，對於混凝土牆壁可直接打安裝孔。整機必須牢固安裝在牆壁上。
	當在牆壁、天花板上進行切割或者鑽孔時，請注意不要損壞電線以及其他隱藏的設備，（如煤氣管道或者水管）。
	為了避免火災的發生并保持空氣清新，外排式吸油煙機出風管必須確保連接到室外將廢氣排出。
	在移動吸油煙機進行安裝、清潔或者修理前，務必切斷電源，以免觸電；在進行安裝、清潔或修理時，應佩戴防護手套，以防被吸油煙機內金屬板快口傷手。
	安裝吸油煙機電源的插座，建議能單獨控制。吸油煙機若長期不用，請切斷電源。

使用

⚠ 嚴格執行

	使用此產品之前，請開箱檢查此產品是否受損，如果發現此產品有明顯的損壞，請勿安裝使用，請您立即聯立方太授權的服務中心。
	本產品僅供家庭日常使用，請不要用于商業用途或在其它特殊環境中使用（例如：室外）；也不能用來排出有危險的或者容易爆炸的物質或者氣體。如您在特殊環境中使用本產品，方太將不承擔任何責任。
	吸油煙機和燃氣灶同時使用時，請確保門窗留有一定間隙，以保證房間內有良好的空氣流通。

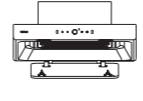
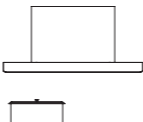
	請按照本說明書規定的方法清洗油煙機，否則吸油煙機有起火的危險。
	集油裝置內的油建議每周清理一次，防止集油過多而溢出。集油裝置中所收集的廢油請勿食用！
	吸油煙機必須安裝在爐灶的正上方，吸油煙機必須保持水平。

⚠ 禁止

	禁止對電源線進行改制、拉伸、結扣以及施加重物、擠壓等，否則易導致電源線破損而發生觸電和火災等事故。
	禁止私自改動吸油煙機內部布線，否則有可能會發生異常動作導致人體受傷。不當修理可能發生觸電、火災等危險。
	吸油煙機排出的廢氣禁止排放到用于排出燃燒燃氣或其他燃料的煙霧使用的熱煙道中。必須遵守相關空氣排放的規定。
	禁止在沒有鍋具的情況下使用燃氣灶，否則會損害上方的吸油煙機。
	禁止觸摸已經開啓或者剛關閉不久的燈泡，以免燙傷。
	吸油煙機運行時禁止將手或其他物品伸入葉輪中以免造成傷害。
	禁止電機、開關、接插件等電氣部件沾水；禁止用水衝洗吸油煙機。吸油煙機被水淋濕后，禁止使用；如果使用會導致漏電、觸電等事故。
	禁止用潮濕的手觸摸電源插頭、電器部件以及操作電源開關，否則易發生觸電事故。
	安裝牆面應為不可燃物，嚴禁安裝在木質等易燃的牆面上。



- 提醒：a. 每次使用吸油煙機后，請擦拭吸油煙機外表面。
b. 爲了更加舒適地使用此吸油煙機，請經常對吸油煙機外表面和集油裝置進行清潔。

安全

注意：與烹飪電器壺同使用時，可觸及的零部件部分可能會變得灼熱。

特別說明：請嚴格按照本說明書規定使用，由于本產品不當使用造成的任何財產損失、人身損害，本公司不承擔責任。

⚠ 警告：此產品不適用於（包括兒童在內）身體、感知或精神能力減弱或缺乏經驗或知識的人群，除非在對其安全負責的人監督或指導如何安全使用此產品的情況下。

⚠ 嚴格執行

 <p>接地</p>	<p>插頭必須插在合理安裝并接地可靠的電源插座上，以確保安全。接地線不得與煤氣管、自來水管、避雷針、電話線等連接。接地不良可能會引起觸電或其他事故。</p>
 <p>安全指南</p>	<p>請遵照加熱設備廠家的安全指南，同時要遵照消防等管理部門頒布的安全標準進行。</p>
	<p>油鍋着火時，請立即關閉吸油煙機（吸油煙機的運行會助燃火勢）。采用有效的滅火方法滅火。例如，用金屬的蓋子將明火蓋住，立即關閉燃氣總閥門，并使易燃物遠離明火。</p>
 <p>T≤40°C</p>	<p>吸油煙機使用環境的溫度不能超過 40°C。</p>
	<p>如果電源線損壞，請聯方太授權服務中心人員進行更換，以避免危險。</p>
	<p>出現異常現象時，關閉吸油煙機電源開關，拔下電源插頭或者切斷總電源，馬上致電方太授權的服務中心。異常狀態下連續運轉易發生觸電、火災等危險。</p>
	<p>請不要讓兒童自己單獨使用，或放到嬰兒能夠接觸到的地方，否則有可能導致燒傷、觸電或者其他意外傷害。</p>
	<p>請勿讓兒童玩耍塑料包裝袋和包裝箱，這可能會產生窒息事故，所以請讓包裝材料遠離兒童，包裝材料不是玩具。應嚴格監管孩童以確保他們不會玩耍產品。</p>

產品信息

產品尺寸

標注的尺寸僅供參考（單位：mm）

EMS6008

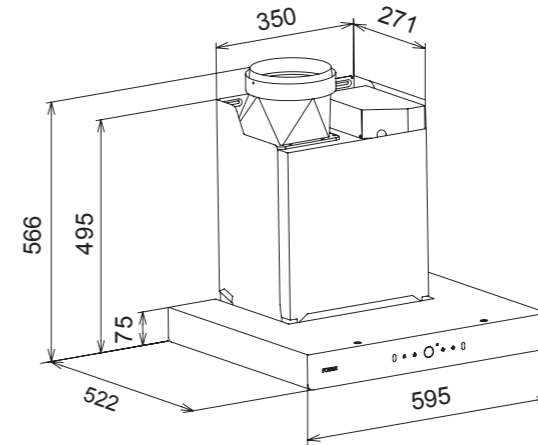

EMS6008-C

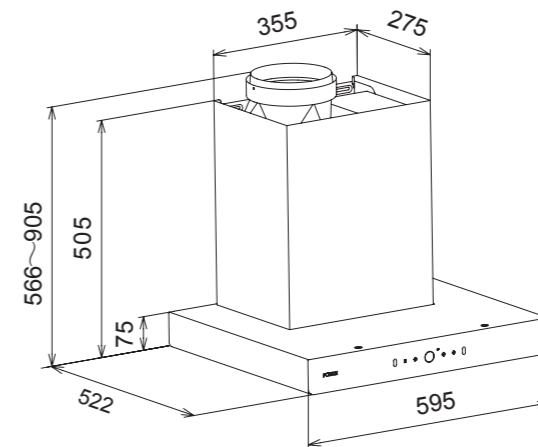

產品性能

產品型號: EMS6008/EMS6008-C

電參數

電壓 / 頻率	電機功率	LED 燈功率	整機輸入功率
220-240V/50Hz	294W	3W×2	300W

性能參數

油脂分離度		96%	氣味降低度		99%
檔位	超強檔	高檔	中檔	低檔	
風量 (m ³ /h)	1180	1120	900	500	
噪音 (dB(A))	57	56	51	39	
最大靜壓 (Pa)	900				

- 注: a. 風量測試按照 IEC 61591 標準。噪音測試按照 IEC 60704-3 標準;
b. 所示噪音值為 A 計權聲壓級, 聲功率級分別為超強檔 69dB(A)、高檔 68dB(A)、中檔 64dB(A)、低檔 51dB(A);
c. 風量、噪音等參數可能會存在 5% 以內的偏差。

使用方法

操作說明

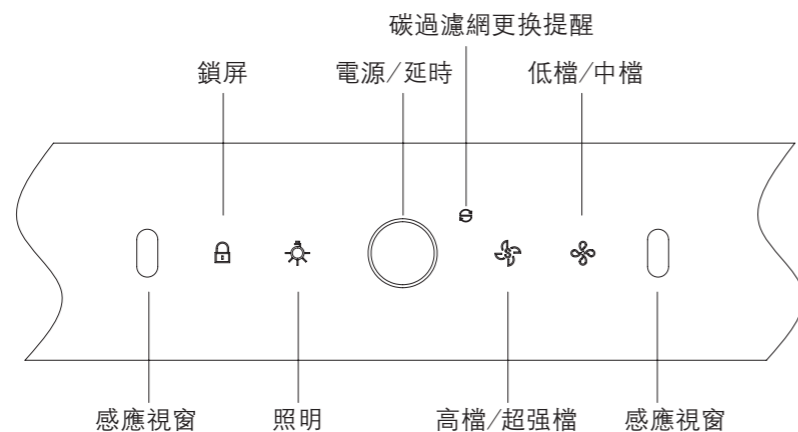

■ 手勢功能

在關機狀態下, 揮手快速經過操作面板兩端感應窗口, 油煙機啓動高檔運行, 并打開照明燈; 再次揮手快速經過操作面板兩端感應窗口, 電源 / 延時鍵 ○ 指示燈閃爍, 油煙機處於延時關機狀態, 照明燈保持原先狀態, 輕觸燈鍵可單獨關閉燈光, 風機以當前狀態運行 1 分鐘后, 切換到低檔運行 4 分鐘, 然后進入關機狀態。

在關機狀態下, 同時按下照明燈鍵 ☀ 和低檔 / 中檔鍵 ☸ 5 秒, 控制板上所有按鍵點亮 1 秒后熄滅, 開啓 / 關閉手勢感應功能。

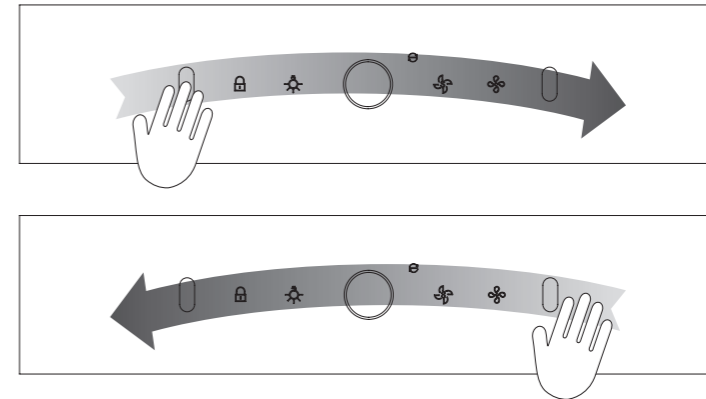

■ 電源 / 延時鍵 ○

在關機狀態下輕觸一下電源 / 延時鍵, 油煙機進入待機狀態, 電源 / 延時鍵指示燈全亮, 其他按鍵指示燈微亮; 在工作狀態下, 輕觸一下電源 / 延時鍵, 電源 / 延時鍵指示燈閃爍, 油煙機處於延時關機狀態, 照明燈保持原先狀態, 輕觸燈鍵可單獨關閉燈光, 風機以當前狀態運行 1 分鐘后, 切換到低檔運行 4 分鐘, 然后進入關機狀態。

在待機狀態或延時關機狀態下, 輕觸一下電源 / 延時鍵, 所有按鍵燈熄滅, 油煙機關機。

以下所有按鍵命令須在待機狀態下進行:

■ 高檔 / 超強檔鍵 ☸

輕觸一下高檔 / 超強檔鍵, 高檔 / 超強檔指示燈半亮, 油煙機在高檔運行; 再輕觸一下高檔 / 超強檔鍵, 高檔 / 超強檔指示燈全亮且閃爍, 油煙機在超強檔運行, 100 秒后油煙機回到高檔運行, 高檔 / 超強檔指示燈半亮。

油煙機在超強檔運行時, 再輕觸一下高檔 / 超強檔鍵, 高檔 / 超強檔指示燈微亮, 油煙機停止運轉。

■ 低檔 / 中檔鍵 ☸

輕觸一下低檔 / 中檔鍵, 低檔 / 中檔指示燈半亮, 油煙機在低檔運行; 再輕觸一下低檔 / 中檔鍵, 低檔 / 中檔指示燈全亮, 油煙機在中檔運行; 再輕觸一下低檔 / 中檔鍵, 低檔 / 中檔指示燈微亮, 油煙機停止運轉。

■ 照明燈鍵 ☀

輕觸一下照明燈鍵, 照明燈全亮, 照明燈打開; 再輕觸一下照明燈鍵, 照明燈微亮, 照明燈關閉。







■ 鎖屏鍵 🔒



在油煙機不運行時, 長按鎖屏鍵 2 秒鐘, 機器“滴”響一聲后, 鎖屏鍵指示燈全亮且閃爍, 所有按鍵被鎖住, 觸按無效; 再長按鎖屏鍵 2 秒鐘, 取消鎖屏功能。

在油煙機風機在運行時, 鎖屏鍵無效, 如果按下會發出“滴、滴”報警聲。

■ 碳過濾網更換提醒

默認處于關閉狀態，僅適用于另外購買和安裝了“碳過濾網”的用戶。

在關機狀態下，同時長按照明燈鍵 、高檔/超強檔鍵  和低檔/中檔鍵  3秒，聽到“滴”的一聲，碳過濾網更換提醒燈點亮1秒后熄滅，開啓碳過濾網更換提醒功能。在此功能開啓狀態下，同時長按照明燈鍵 、高檔/超強檔鍵  和低檔/中檔鍵  3秒，聽到“滴”的一聲，關閉碳過濾網更換提醒功能。

當碳過濾網更換提醒被點亮時，證明油煙機裏的碳過濾網須更換。在關機狀態下更換完后，請同時長按照明燈鍵  和高檔/超強檔鍵  3秒，聽到“滴”的一聲碳過濾網更換提醒燈熄滅，更換過程結束。



- 提示：
1. 待機狀態下2分鐘沒有操作，油煙機會自動關機；
 2. 建議蒸煮時開啓吸油煙機，保持廚房空氣清新，否則較多水蒸氣經過感應窗口可能會觸發手勢功能；
 3. 過濾網具體更換流程請參照后面 P9 “碳過濾網更換”。

清潔保養

- ⚠ 警告：
1. 如果不按說明書規定的方法清洗吸油煙機有起火的危險。
 2. 當清潔、維修吸油煙機前，務必先拔掉電源綫插頭，以免觸電。
 3. 清潔時應防止電機、各控制鍵等電氣部件進水。
 4. 當風機在運行時，禁止將手放入風機運轉區域。
 5. 切勿使用汽油、苯等溶劑或任何強碱強酸等腐蝕性化學藥劑清洗油煙機。

爲了更加舒適的使用，請經常對吸油煙機表面、集油裝置及前濾網進行清潔。經常清潔吸油煙機表面、集油裝置及前濾網將有利于延長吸油煙機使用壽命。

整機表面清潔

- ⚠ 警告：請不要使用清潔球、刷子以及粗布等粗糙物進行清潔，以免劃傷機體表面。
1. 用中性皂或者中性洗滌劑進行清潔，清潔后用柔軟的布擦干機體表面；
 2. 如果吸油煙機表面有頑固污垢，使用中性清潔劑清潔。把清潔劑滴至污垢處并短暫停留，使用柔軟的抹布將污垢擦去，用微濕的毛巾將清潔劑除去并擦干油煙機表面；
 3. 不要讓污漬在吸油煙機表面停留時間過長；
 4. 不小心將含鹽的溶液、消毒劑、漂白粉以及其他清潔劑沾到不銹鋼表面（這些溶劑中大部分含有有害的化學成分），應立即用濕布擦拭，然后用干布擦干。

蝶翼板清潔

1. 首先，用雙手抓住蝶翼板前沿，向下翻轉，使蝶翼板卡扣脫離（見 Fig.1），然后向下翻轉一定角度，最后雙手平端着蝶翼板向外取出（見 Fig.2）；
2. 將蝶翼板放入加有中性洗滌劑的溫水中浸泡，用軟刷將其清洗干淨，或放入洗碗機中清洗；
3. 清潔完畢擦干后，裝上蝶翼板。

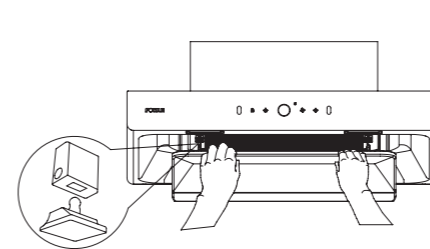

Fig.1

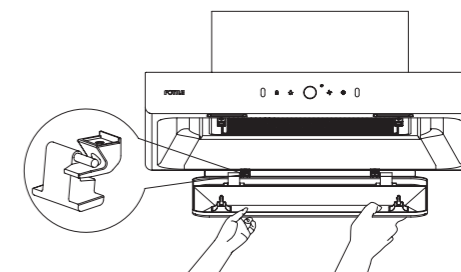

Fig.2

油網清潔

1. 首先，取下蝶翼板（見 Fig.1 和 Fig.2）；
2. 擰下油網螺釘，取下油網（見 Fig.3 和 Fig.4）；
3. 將前濾網放入加有中性洗滌劑的溫水中浸泡，用軟刷將其清洗干淨；
4. 清潔完畢晾干后，裝上油網和蝶翼板。

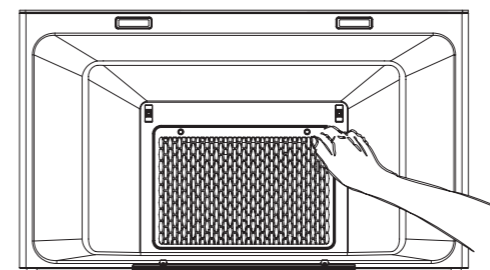

Fig.3

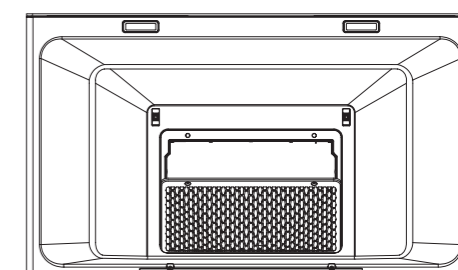

Fig.4

清潔保養周期

清潔部件	建議清潔（或更換）周期
整機表面	每次使用油煙機后
蝶翼板	每周清潔

注：具體清潔周期請根據實際烹飪情況決定。

常見故障的識別和處理

常見故障處理表

故障現象	可能原因	檢修方法
吸油煙機不工作，LED 燈不亮	未接通電源	檢查電源插頭是否插好 檢查插座是否有電
電機轉動但 LED 燈不亮	LED 燈損壞	更換 LED 燈
有機械振動噪聲	螺釘鬆動	檢查吸油煙機表面螺釘是否擰緊
吸油煙效果不好	吸油煙機與灶面的安裝距離太大	降低吸油煙機安裝高度（本項必須由專業人士進行）
	吸油煙機周圍環境門窗通風太多，對流太大	減小門窗通風或關閉部分門窗
揮手功能無反應	手勢功能處於關閉狀態	按照 P7 頁手勢功能操作，重新開啓手勢功能

免責說明

- 上述故障排除后，吸油煙機仍不能正常工作，請聯系方太授權的服務中心。
- 非方太授權的服務中心人員不得擅自維修吸油煙機，以免造成嚴重后果，而且產品將不享受保修服務。
- 以下情況不提供保修服務：
 - 用戶搬運、安裝、使用、維護、保管不當而損壞的。
 - 超出正常使用條件，強行使用本產品造成的故障和損傷（例如電壓超出 264V 或低于 189V 而損壞的）。
 - 自行或非方太授權服務人員或服務機構安裝和拆修的產品。
 - 購買憑證和保修卡信息與產品不符的。
 - 因不可抗力造成產品損壞的（如自然災害、戰爭等）。

維修說明

需要提供以下信息：

- 購買日期
- 產品型號
- 序列號（具體位置請查看扉頁指示位置）
- 購買相關憑證

LED 燈更換

- 拔掉油煙機電源插頭，或關閉插座電源；

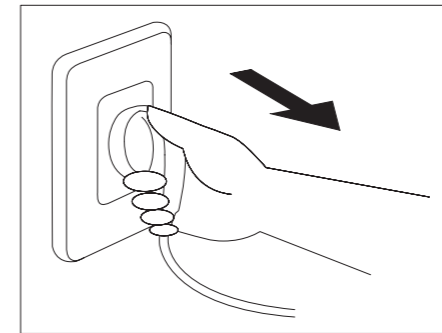

- 用小型一字螺絲刀輕微插入燈邊緣，下撬并取出燈組件；

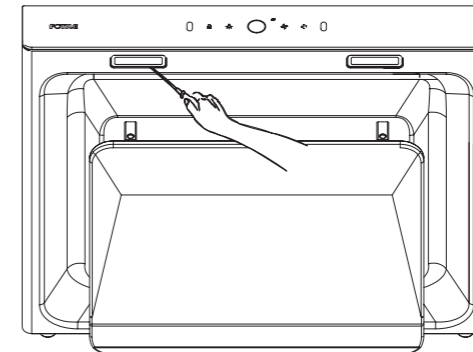

- 拆開燈連接線，更換整個 LED 燈（裝燈時燈綫朝牆壁方向安裝）。

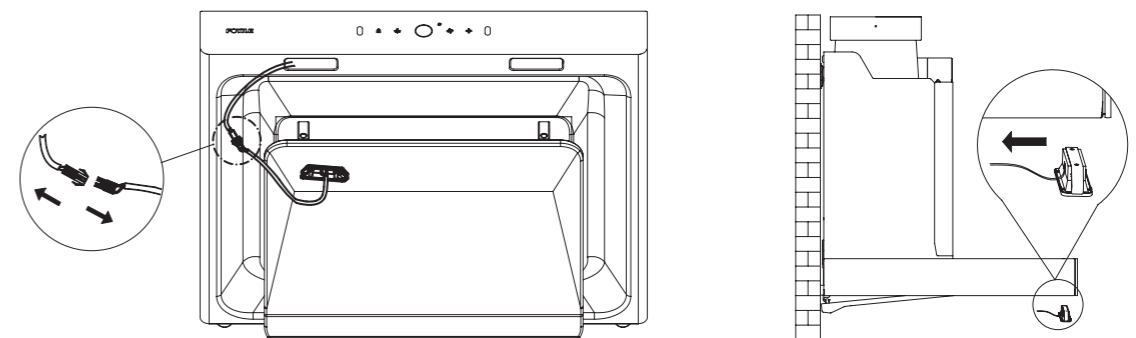

電擊危險：在更換 LED 燈前，請先拔下電源插頭或者切斷油煙機插座電源，以免觸電。

安裝

安裝高度

標注的尺寸僅供參考 (單位: mm)
外排式安裝示意圖

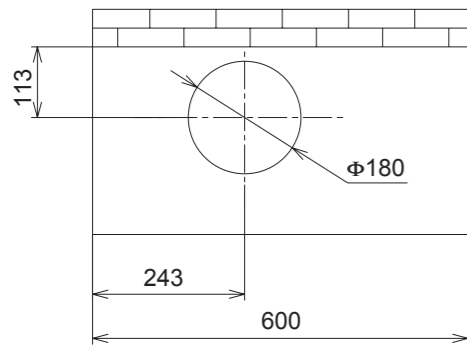

吊頂或櫥櫃頂板開孔尺

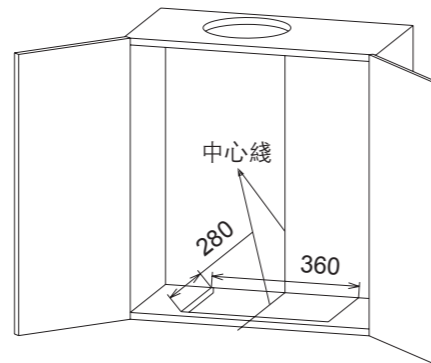

櫥櫃底板開孔尺寸

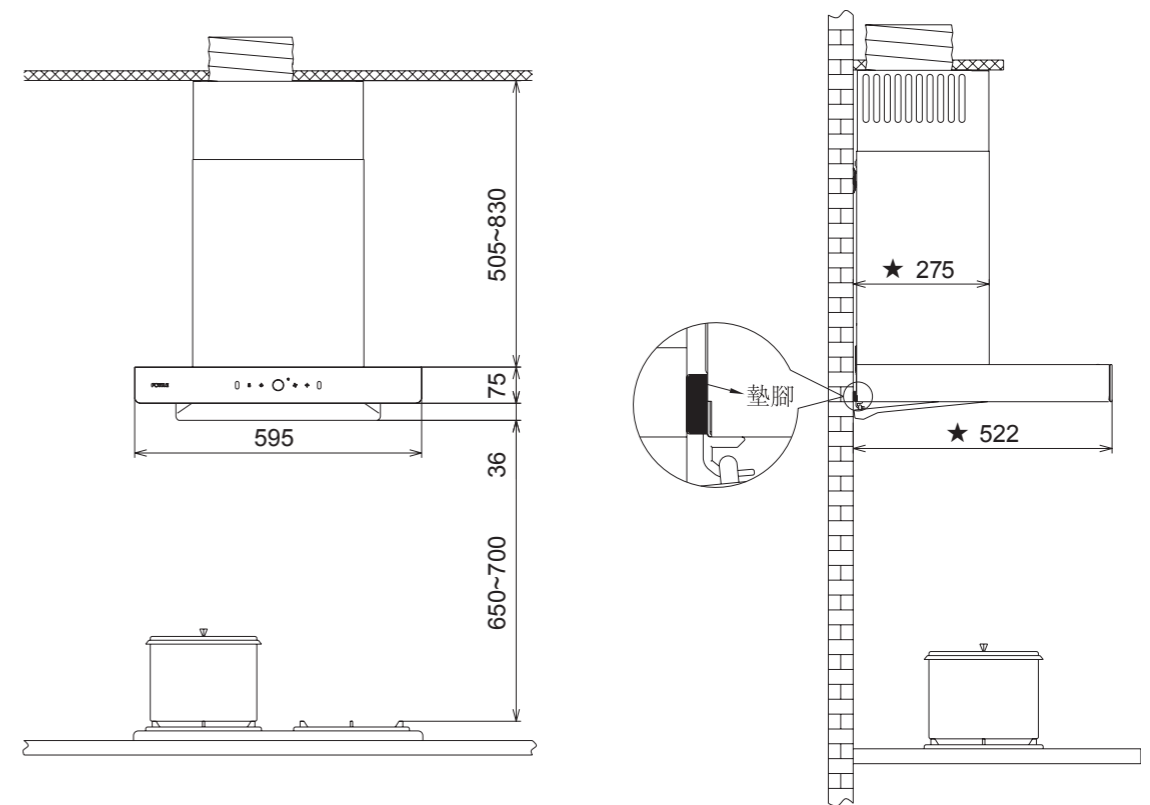

EMS6008-C 安裝示意圖 (★表示到牆距離)

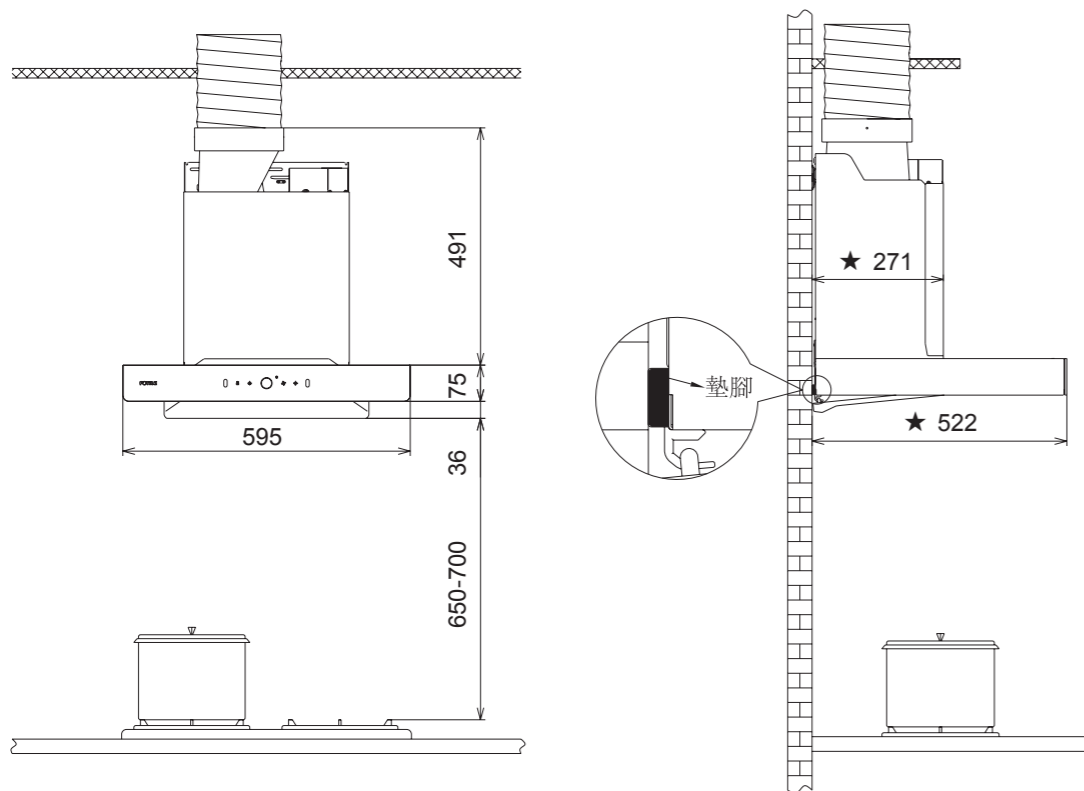

EMS6008 安裝示意圖 (★表示到牆距離)

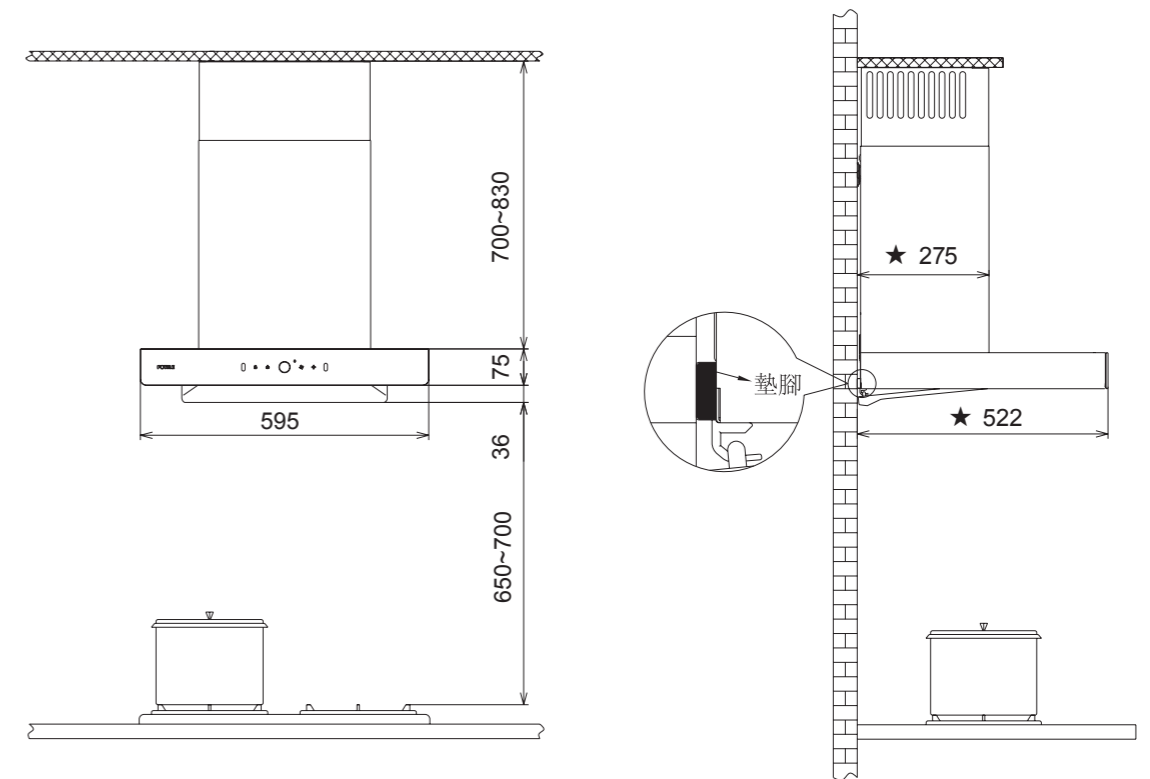

內循環式安裝示意圖 (★表示到牆距離)

- 備注：1. 吸油煙機的安裝高度為推薦值（此高度為淨空值，即爐灶上烹飪器具的支承面與吸油煙機最低部位的距離），圖示櫥櫃與吸油煙機搭配示意僅供參考。
2. 吸油煙機集煙罩與兩側櫥櫃需要預留間隙才能安裝或拆卸，請予以注意。
3. 如所在地區有相關法律規定油煙機高度要求，建議遵守相關法律，但是產品的吸油煙效果可能會受到較大影響。

攏煙範圍

油煙機左右攏煙範圍

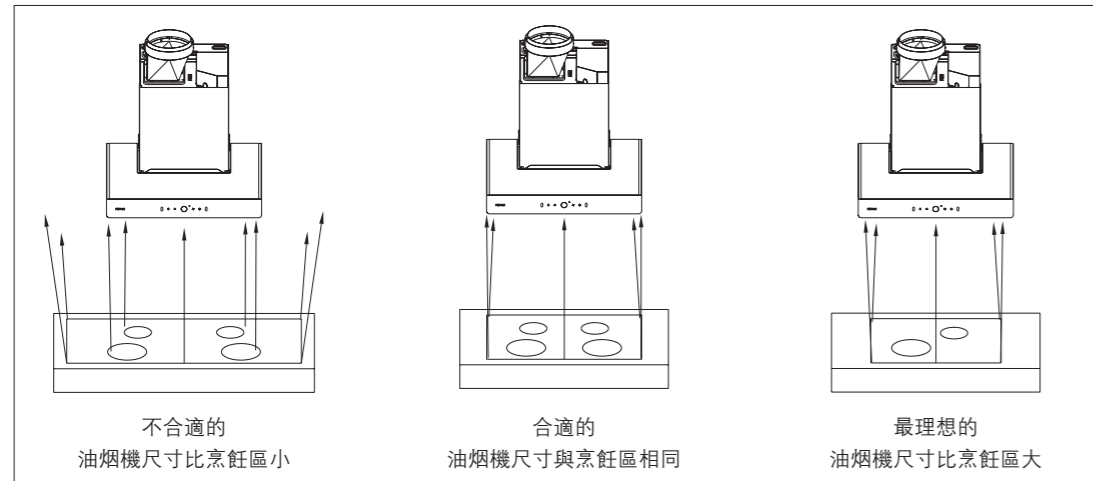

油煙機前後攏煙範圍

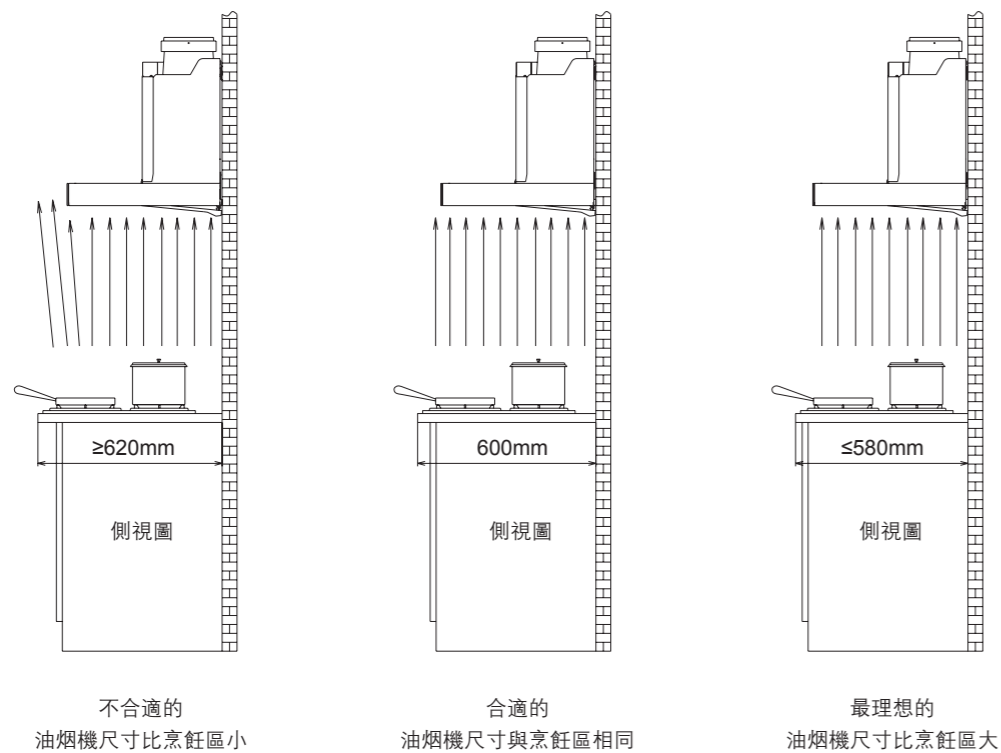



裝箱清單

	主機（軸測圖）	1		蝶翼板	1
	出風管	1		出風罩	1
	密封膠帶	1		上密封墊	1
	掛鈎	1		產品使用說明書	1
	保修卡	1		轉接頭	1
	掛鈎螺釘 ST4.2×36mm	7		木螺釘 ST5×65mm	4
	瓷磚膨脹管 φ5.3×32mm	7		石膏板膨脹管 φ4×40mm	4
	出風罩螺釘 M4×18mm	8		出風管螺釘 ST3.9×9.5mm	4
	風機架螺釘 M4×6mm	2		裝飾罩掛鈎螺釘 ST2.9×19mm	2 (EMS6008-C 專用)
	風機外罩	1 (EMS6008-C 專用)		裝飾罩	1 (EMS6008-C 專用)
	裝飾罩掛鈎	1 (EMS6008-C 專用)		蝶翼板掛架組件	1

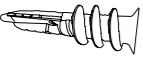
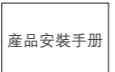

以下配件須另外單獨購買（請聯立方太授權網點）

外罩組件清單					
	風機外罩	1		裝飾罩	1
	裝飾罩掛鈎	1		掛鈎螺釘 ST4.2×36mm	2

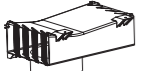
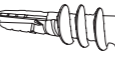

	石膏板膨脹管 φ4×40mm	2		產品安裝手冊	1
	裝飾單掛鈎螺釘 ST2.9×19mm	2		墊條	4

內循環配件清單

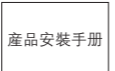
遵風箱配件清單

	導風箱組件	1		石膏板膨脹管 φ4×40mm	5
	掛鈎螺釘 ST4.2×36mm	5		產品安裝手冊	1

碳網過濾清單

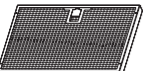
	連接支架	1		前濾網	1
	碳過濾網	1			

安裝前注意事項

安全注意事項

☆特別說明：為保障安全和正確使用本產品必須由方太授權的服務人員進行安裝和維修。如因用戶委托非方太指派的人員或用戶自行安裝和維修，而導致產品不能正常使用的，即使在保修期內，也不在免費維修範圍。

在安裝以前，請仔細閱讀所有的說明。請特別注意以下事項：

- 如果您正在對您的廚房進行裝修，請勿將吸油煙機暴露在外。因為建築材料、灰塵、油漆、塗料以及它們所揮發的氣體，會使吸油煙機表面產生腐蝕以及失去光澤。建議在廚房裝修完畢以后再安裝吸油煙機。
- 由于本吸油煙機的安裝程序比較複雜，且重量較重，應由方太授權的專業服務人員按照說明書進行安裝。
- 在清潔吸油煙機周圍物品（如吊頂、櫥櫃）有可能會觸及吸油煙機時，請戴上防護手套及做好其他防護措施，以防磕傷或劃傷。
- 在牆壁上鑽孔時，請注意不要損壞電綫以及其他隱藏的設備。安裝時不能接通電源，應在主電源箱中關閉電源。
- 吸油煙機應使用專用電源插座，并且專用電源插座應有可靠接地。因電源綫中途連接、使用延長綫以及多口配綫器時易發生觸電、插頭插座發熱以及火災。請確保由專業的電工來操作，并且要嚴格按照所有適用的國家和地區的電力法規：在接綫前，請先關閉電源并采取合理措施防止電源自動接通。
- 如果在安裝吸油煙機前，需要移動燃氣灶，則在移動燃氣灶之前，請先關閉燃氣總閥門。

- 安裝吸油煙機牆壁要有足夠的強度。
- 為確保安全和安裝順利，安裝膨脹管時，膨脹管與牆孔的配合定要緊密，嚴禁鑽孔過大，以免膨脹管鬆動，造成意外跌落！
- 為了避免火災的發生并保持空氣清新，外排式吸油煙機出風管必須確保連接到室外將廢氣排出。
- 吸油煙機排出的廢氣不能排放到用于排出燃燒燃氣或其他燃料的煙霧使用的熱煙道中。
- 安裝時須盡量保證機身水平。
- 安裝完畢，經試運轉無異常現象后確認合格。請用戶注意仔細閱讀，妥善保存本說明書。
- 吸油煙機安裝牆面存在圖 Fig.1 所示臺階差時，若存在圖 Fig.2 所示情況，請按照 Fig.3 操作，即在掛鈎及油煙機墊腳背部增加支撐板，要求支撐板厚度與臺階高度一致。

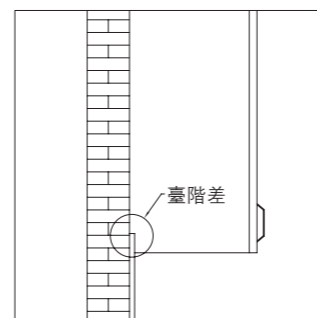

Fig. 1

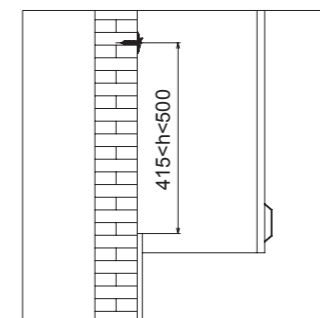

Fig. 2

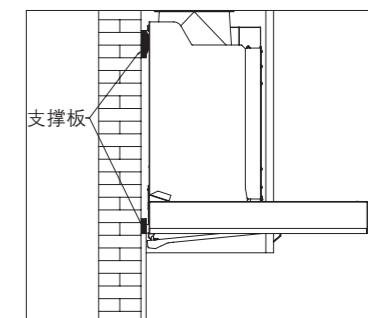

Fig. 3

安裝位置

- 該吸油煙機只能安裝于家庭廚房，請勿在其他場合使用該吸油煙機。
- 必須安裝在爐灶的上方，安裝位置按安裝示意圖所示。
- 吸油煙機周圍環境的溫度不能超過 40°C。
- 安裝牆面應為不可燃物，嚴禁安裝在木質等易燃的牆面上。
- 請按照本說明書建議安裝尺寸進行安裝，以保證最佳吸油煙效果。

安裝前準備工作

⚠ 警告：為了不對吸油煙機造成損害，請確保不要讓雜物等進入排風口。

- 估算吸油煙機通到室外的出風管的位置，參見安裝示意圖。
- 一個直綫的較短的出風管將使得吸油煙機的排煙更加順暢。
- 盡量避免使用過長以及有較多彎道的出風管，使用這些管道將影響吸油煙機的排煙效果。
- 出風管與牆孔的連接處使用管道膠帶嚴格進行密封。同時必須確保出風管與出風罩連接牢固。
- 牆洞過小會影響排煙效果，在保證安全的前提下，建議擴孔至原配。

工具準備

安裝本吸油煙機應具備以下工具

- | | |
|-----------------|-----------|
| (1) 衝擊電鑽（帶鑽頭φ8） | (2) 十字螺絲刀 |
| (3) 鋼絲鉗 | (4) 卷尺 |
| (5) 曲綫鋸 | (6) 水平尺 |

外排安裝

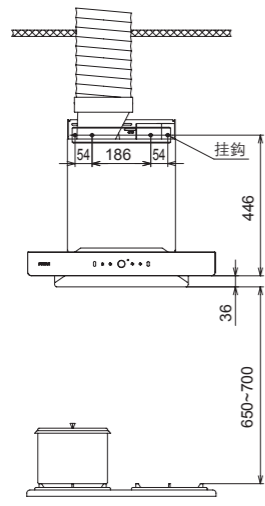

EMS6008安裝尺寸圖(單位: mm)

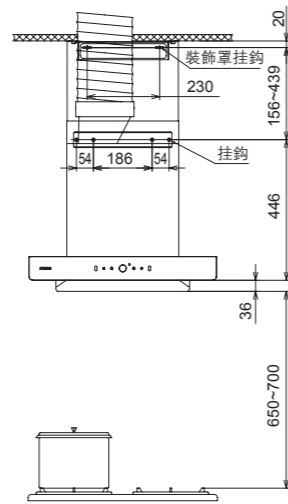

EMS6008-C安裝尺寸圖(單位: mm)

警告：請戴防護手套操作。

1. 打開包裝箱拿出主機，清點裝箱清單；（裝箱清單見 P15）

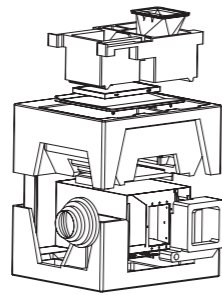

2. 取下風機外罩、裝飾罩（僅適用於 EMS6008-C）：用螺絲刀取下主機背后固定風機外罩的 2 顆螺釘（見 Fig.6），然後雙手抓住風機外罩和裝飾罩向上將其取出（見 Fig.7）；

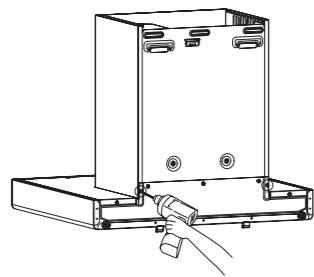

Fig.6

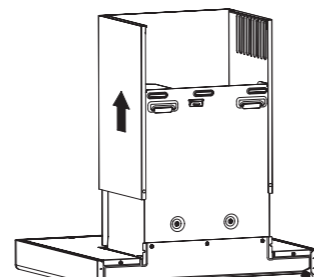
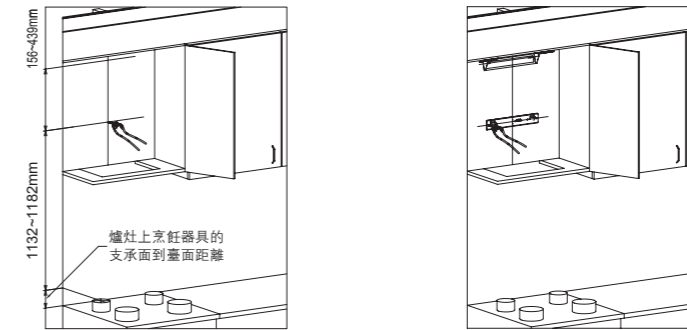

Fig.7

3. 確認固定掛鉤的位置：首先確認油煙機安裝中心點，畫一條垂直線的中心線，然後以爐竈上烹飪器具的支承面為基準點在堅實的牆壁上準確確定掛鉤安裝位置，做好打孔標志。
主機掛鉤尺寸為：爐竈上烹飪器具的支承面到掛鉤螺釘孔 1132mm~1182mm；
裝飾罩掛鉤（EMS6008-C 專用）尺寸為：主機掛鉤螺釘孔到裝飾罩掛鉤螺釘 156mm~439mm；



注：若發現瓷磚、大理石、玻璃等裝飾板突出於掛鉤安裝面，則請參考 P17 “安裝注意事項” 中第 13 點執行。

4. 固定掛鉤：

- 1) 打孔標識處是瓷磚（大理石）：在打孔標識處用電鑽打 $\phi 8\text{mm}$ 孔，並埋設瓷磚膨脹管（ $\phi 5.3 \times 32\text{mm}$ ），用掛鉤螺釘（ST4.2×36mm）固定掛鉤，并用水平尺確保掛鉤水平；
- 2) 打孔標識處是石膏板：在打孔標識處直接用螺絲刀將石膏板膨脹管（ $\phi 4 \times 40\text{mm}$ ）擰進牆面，然後用掛鉤螺釘（ST4.2×36mm）固定掛鉤，并用水平尺確保掛鉤水平；

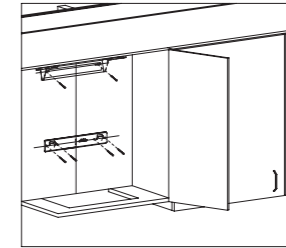
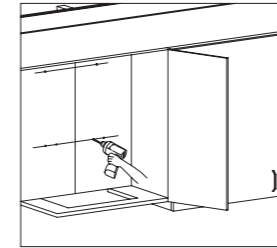

- 3) 針對 EMS6008-C，裝飾罩掛鉤可用 2 顆裝飾罩掛鉤螺釘（ST2.9×19mm）固定到吊頂上。

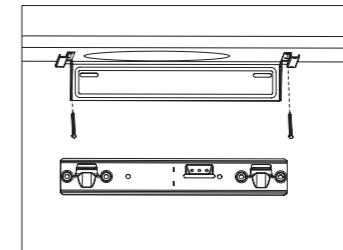

- 注意：a. 根據安裝處牆壁材料的具體情況選定鑽頭。
b. 固定油煙機掛鉤的螺釘必須有 2 顆固定在牆壁後的木柱上。

5. 櫥櫃底板開孔：首先確認櫥櫃底板中心線，再根據上櫥櫃底板開孔尺寸（見下圖）畫好開孔線，最後用割木板工具切割好上櫥櫃底板孔；

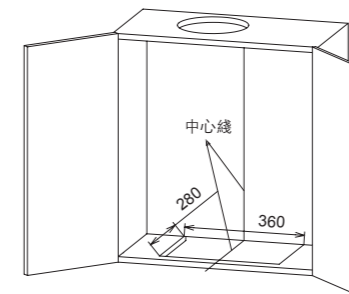

6. 安裝出風管：當公共烟道接口或牆孔大于鋁箔出風管直徑時，可以直接連接鋁箔出風管。公共烟道接口或牆孔小于鋁箔出風管直徑時，在鋁箔出風管無塑料固定圈端套上風管轉接口并用膠帶粘接密封。風管轉接口小端有外徑 140mm 和 115mm 兩種規格，請根據實際情況將小于公共烟道接口或牆孔的多余部分剪去；



- 注意：a. 出風管與公共烟道接口或牆孔間密封嚴密以防漏烟，出風管不能擠壓變形、小角度轉彎；轉彎數量不超過 1 個，最后須拉直并固定；
b. 公共烟道接口或牆孔直徑應與出風管直徑基本保持一致，不應過小，否則會造成排烟不暢、噪音升高和風量降低等情況。

7. 安裝出風罩：用 8 顆出風罩螺釘（M4×18mm）將出風罩及密封圈固定在主機出風口處；

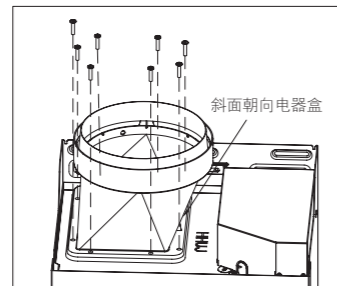

8. 把頂板表面保護膜撕掉；

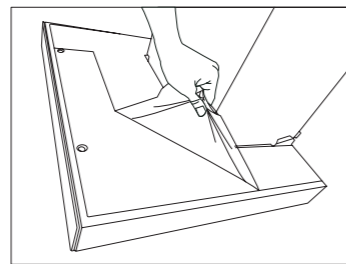

9. 抬起主機，讓風機架穿過櫥櫃底板，將背部掛鉤孔挂入掛鉤，用水平尺確認主機水平，并用風機架螺釘（M4×6mm）將風機架與掛鉤固定；

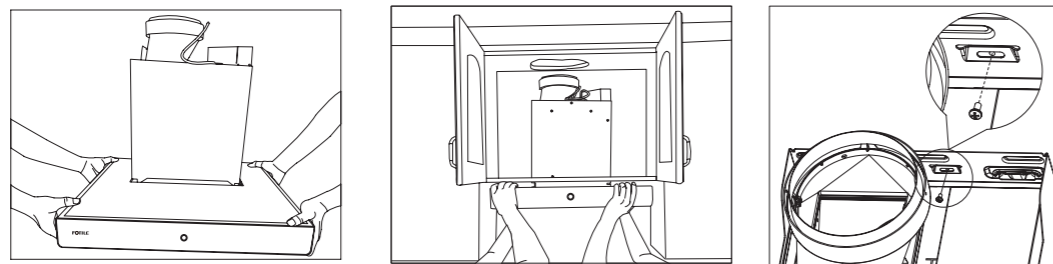

10. 連接、固定出風管：根據主機實際安裝位置，用鋼絲鉗剪去多余出風管，然后用 2 顆出風管螺釘（ST3.9x9.5）將出風管固定在出風罩上，用密封膠帶纏繞密封；

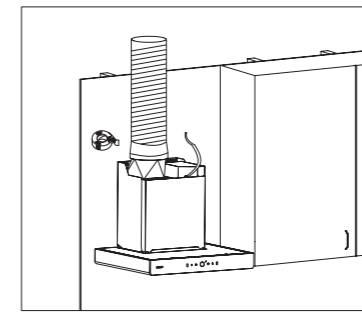

11. 將主機電源插頭插入電源插座，啟動油煙機，檢查出風管與出風罩連接處是否密封完好；

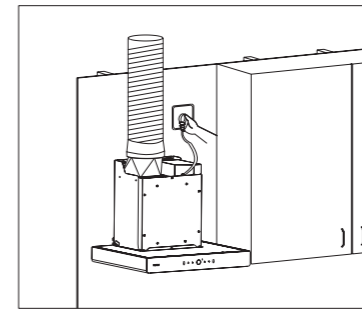

12. 安裝風機外罩、裝飾罩（僅適用於 EMS6008-C）；
1) 把風機外罩、裝飾罩表面保護膜撕掉；

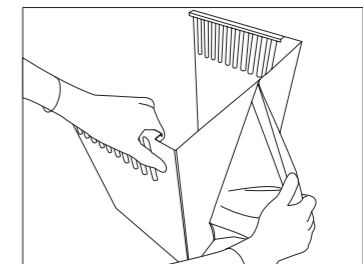
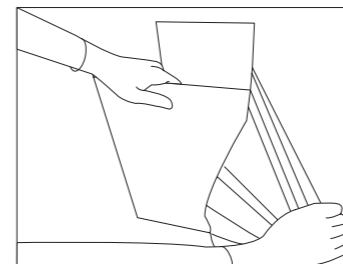

- 2) 將裝飾罩放入風機外罩內；

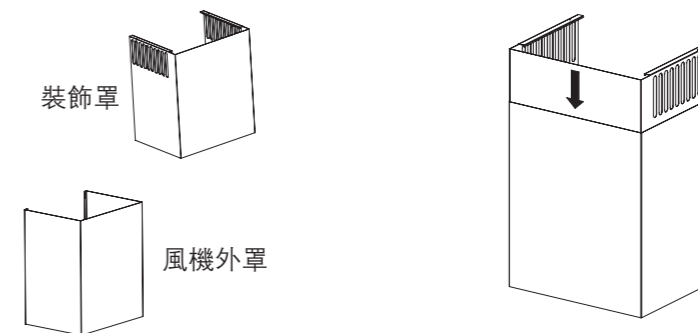

3) 把風機外罩、裝飾罩同時拿起，先把裝飾罩挂在裝飾罩掛鉤上，然後同時將裝飾罩、風機外罩沿裝飾罩掛鉤推到底；

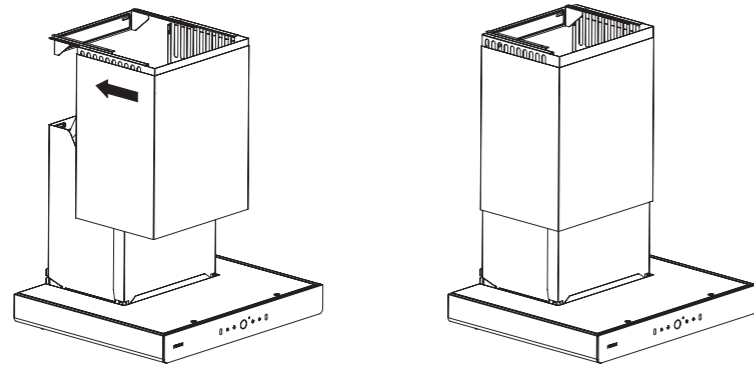

4) 風機外罩緩緩滑下，將風機外罩卡扣卡入風機架，然後將風機外罩插入頂板與風機架的間隙內。

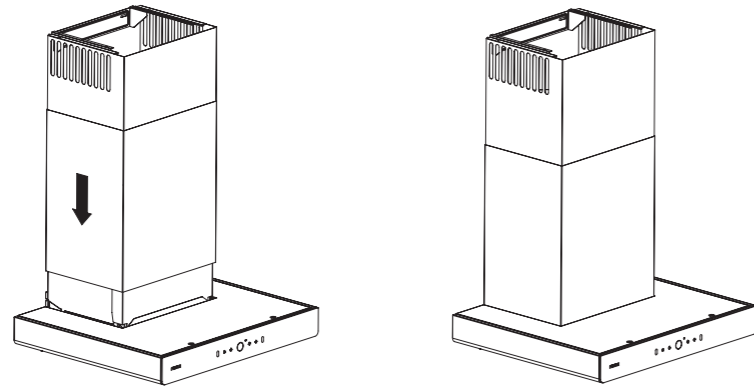

13. 安裝蝶翼板掛架；

1) 取出蝶翼板掛架組件；

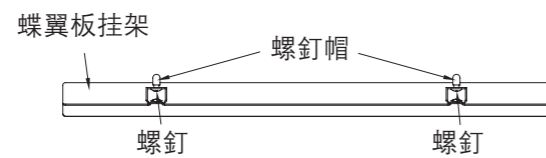

2) 去掉螺釘帽；

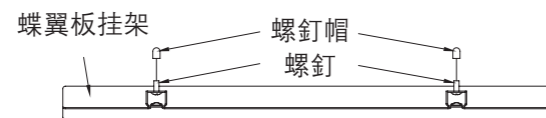

3) 用十字螺絲刀將蝶翼板掛架固定在油煙機底部。

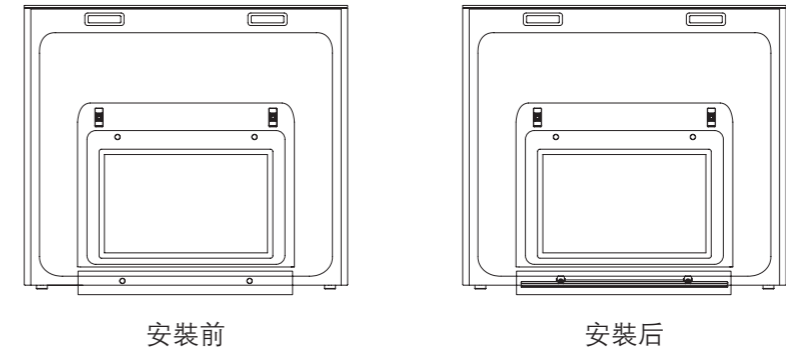

14. 安裝蝶翼板；

1) 把蝶翼板表面保護膜撕掉；

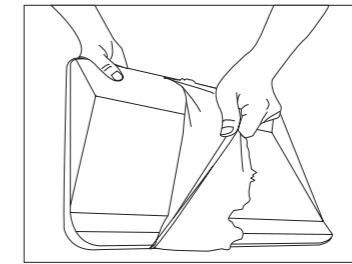

2) 雙手緊握蝶翼板前側，將蝶翼板後側的左右掛鉤，放入集煙罩底部的掛鉤架內；

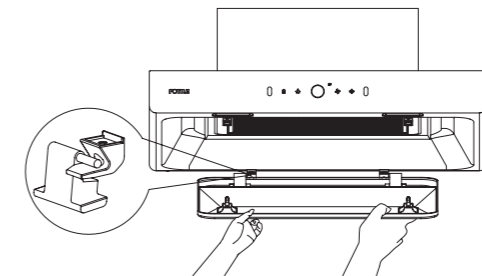

3) 雙手拖住蝶翼板，使其向上旋轉，然後用力將蝶翼板卡扣卡入集煙罩上的碰扣內。

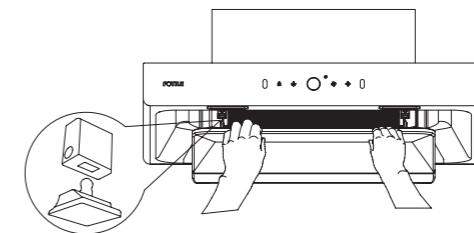

注：a. 所有附件（如蝶翼板等）請按要求完成安裝，否則可能引起火災。
b. 若需用非常大的力氣將蝶翼板卡扣卡入集煙罩上的碰扣內，請參考 P17“安裝注意事項”中第 13 點檢查油煙機安裝面狀態，並按其提示進行操作。

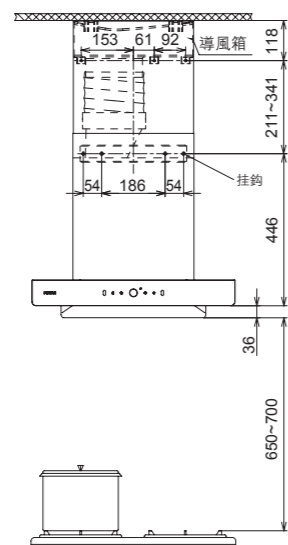

警告：請戴防護手套操作。

1. 打開包裝箱拿出主機，清點裝箱清單（裝箱清單見 P15）；

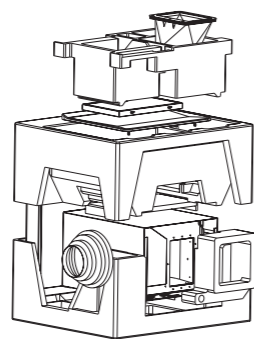

2. 取下風機外罩、裝飾罩（僅適用於 EMS6008-C）：用螺絲刀取下主機背后固定風機外罩的 2 顆螺釘（見 Fig.8），然後雙手抓住風機外罩和裝飾罩向上將其取出（見 Fig.9）；

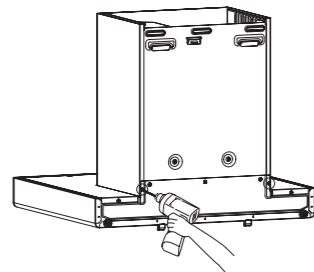

Fig.8

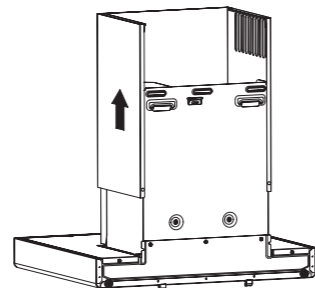

Fig.9

3. 確認固定主機掛鈎和導風箱的位置：首先確認油煙機安裝中心點，畫一條垂直線的中心綫，然後以爐灶上烹飪器具的支承面為基準點在堅實的牆壁上準確確定主機掛鈎和導風箱

安裝位置，做好打孔標志。

主機掛鈎尺寸為：爐灶上烹飪器具的支承面到掛鈎螺釘孔 1132mm~1182mm；

導風箱尺寸為：導風箱頂面須貼吊頂安裝，導風箱下端螺釘孔到吊頂 118mm，且須保證主機掛鈎螺釘孔到導風箱下端螺釘孔在 211mm~341mm 範圍內；

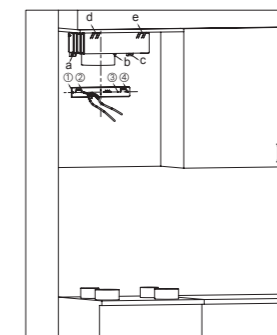
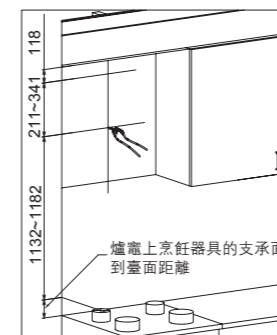

注：若發現瓷磚、大理石、玻璃等裝飾板突出於掛鈎安裝面，則請參考 P17 “安裝注意事項”中第 13 點執行。

4. 用密封膠帶，將出風管固定在導風箱上；

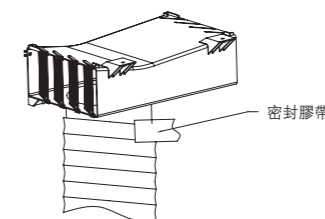

5. 固定主機掛鈎；

- 1) 打孔標識處是瓷磚（大理石）：在打孔標識處用電鑽打 $\phi 8\text{mm}$ 孔，並埋設瓷磚膨脹管（ $\phi 5.3 \times 32\text{mm}$ ），用掛鈎螺釘（ $\text{ST}4.2 \times 36\text{mm}$ ）固定掛鈎，并用水平尺確保掛鈎水平；
- 2) 打孔標識處是石膏板：在打孔標識處直接用螺絲刀將石膏板膨脹管（ $\phi 4 \times 40\text{mm}$ ）擰進牆面，然後用掛鈎螺釘（ $\text{ST}4.2 \times 36\text{mm}$ ）固定掛鈎，并用水平尺確保掛鈎水平。

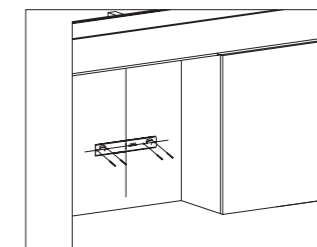
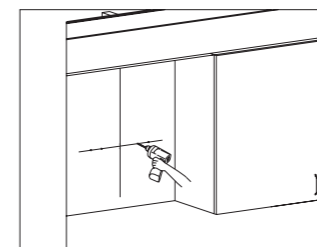

注：固定油煙機掛鈎的螺釘必須有 2 顆固定在牆壁後的木柱上。

6. 固定導風箱：在打孔標識處（背牆 3 處，吊頂上 2 處）直接用螺絲刀將石膏板膨脹管（ $\phi 4 \times 40\text{mm}$ ）擰進牆面，然後用掛鈎螺釘（ $\text{ST}4.2 \times 36\text{mm}$ ）固定導風箱；

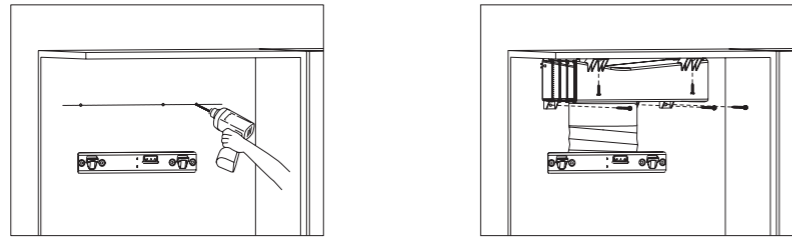

7. 安裝出風罩：用 8 顆出風罩螺釘 M4×18mm 將出風罩及密封圈固定在主機出風口處；

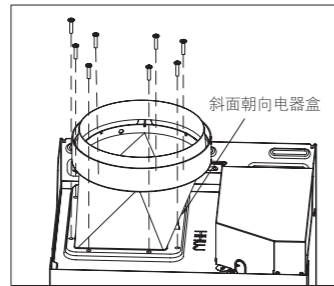

8. 把頂板表面保護膜撕掉；

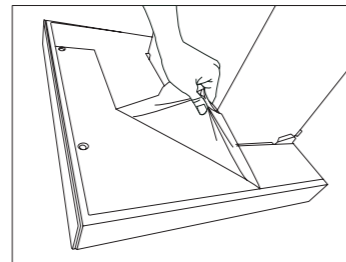

9. 抬起主機，將背部掛鉤孔挂入掛鉤，用水平尺確認主機水平，并用風機架螺釘（M4×6mm）將風機架與掛鉤固定；

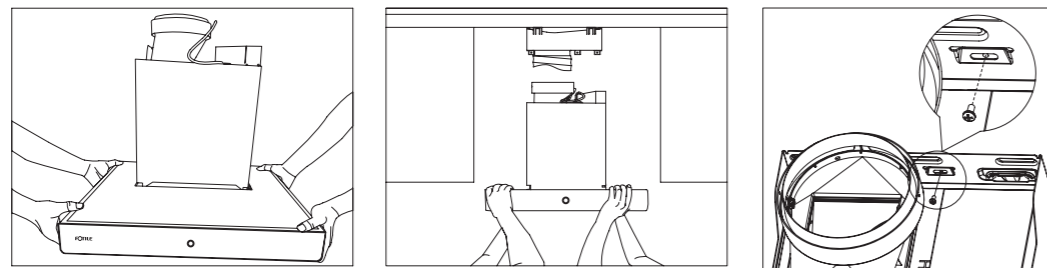

10. 連接、固定出風管：根據主機實際安裝位置，用鋼絲鉗剪去多余出風管，然后用 2 顆 ST3.9x9.5mm 螺釘將出風管固定在出風罩上，用密封膠帶纏繞密封；

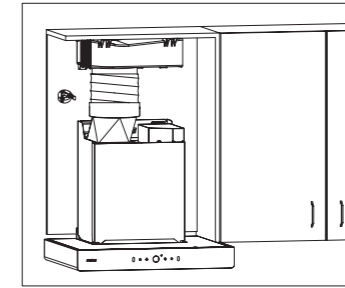

11. 將主機電源插頭插入電源插座，啓動油煙機，檢查出風管與出風罩連接處是否密封完好；

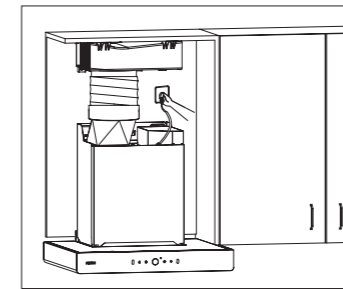

12. 安裝風機外罩、裝飾罩：

1) 把風機外罩、裝飾罩表面保護膜撕掉；

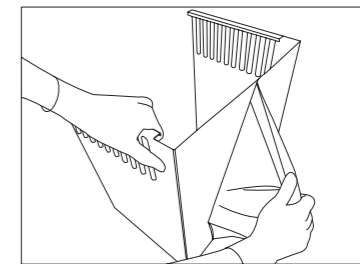
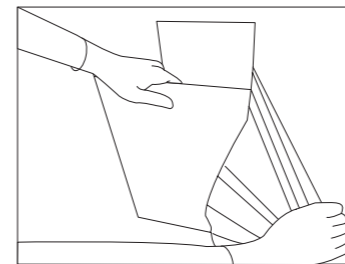

2) 將裝飾罩放入風機外罩內；

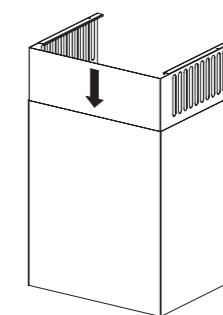
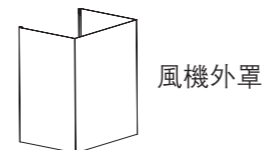
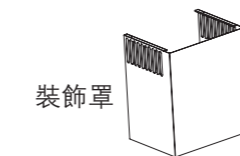

3) 把風機外罩、裝飾罩同時拿起，先把裝飾罩挂在導風箱上，然后同時將裝飾罩、風機外罩沿導風箱推到底；

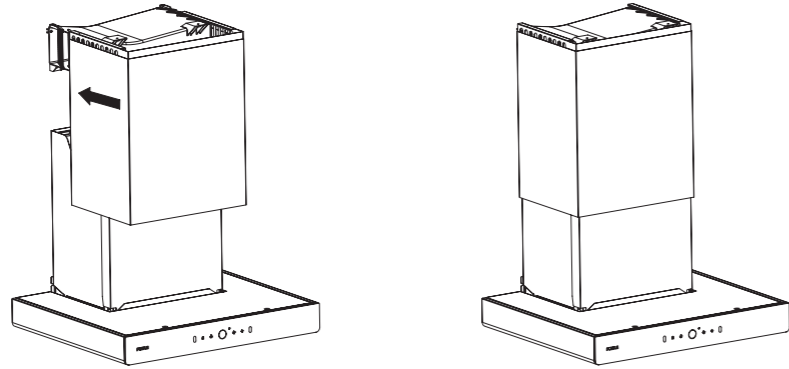

4) 風機外罩緩緩滑下來，將風機外罩卡扣卡入風機架，然后将風機外罩插入頂板與風機架的間隙內。

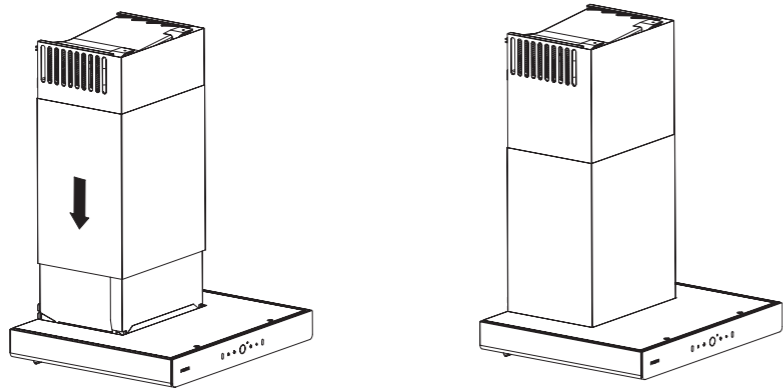

13. 安裝碳過濾網；

1) 首先直接扳開前濾網卡扣，取下前濾網；

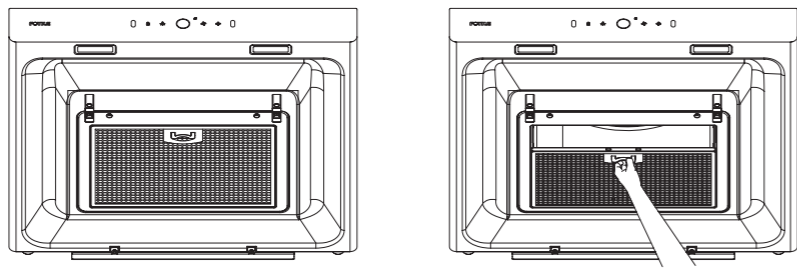

2) 安裝碳過濾網；

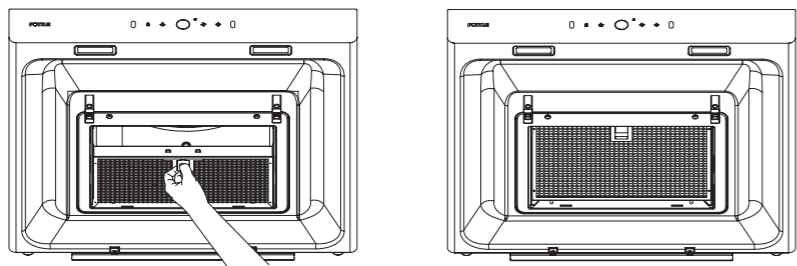

3) 最后將取下的前濾網安裝在原位置。

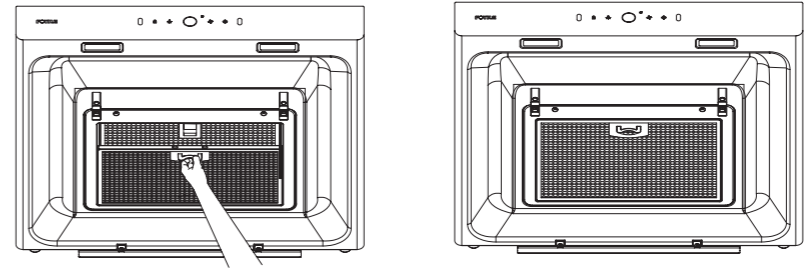

14. 安裝蝶翼板挂架；

1) 取出蝶翼板挂架組件；

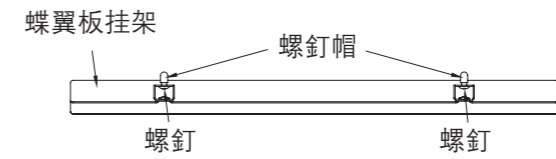

2) 去掉螺絲帽；

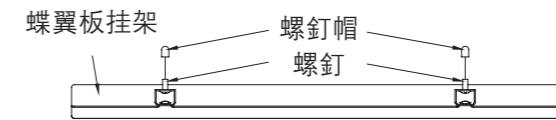

3) 用十字螺絲刀將蝶翼板挂架固定在油煙機底部。

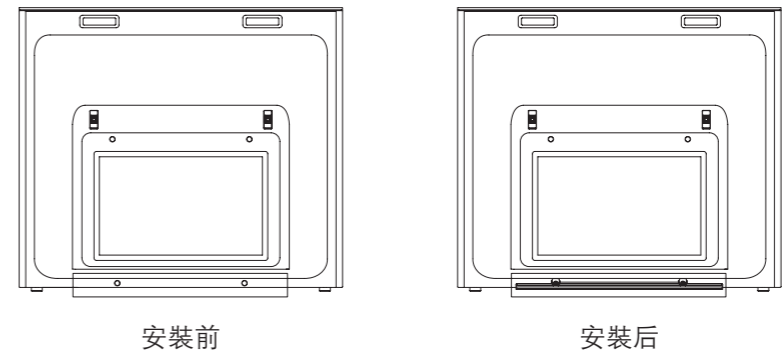

15. 安裝蝶翼板；

1) 把蝶翼板表面保護膜撕掉；

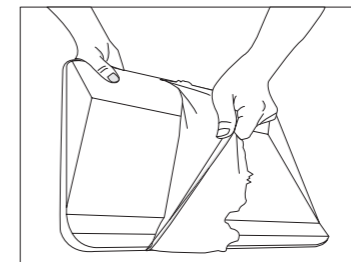

2) 雙手緊握蝶翼板前側，將蝶翼板后側的左右掛鉤，放入集煙罩底部的掛鉤架內；

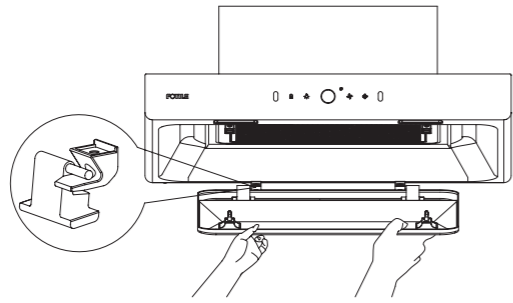

3) 雙手拖住蝶翼板，使其向上旋轉，然後用力將蝶翼板卡扣卡入集煙罩上的碰扣內。

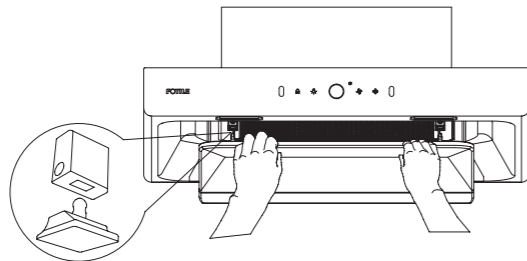

注：1. 所有附件（如蝶翼板等）請按要求完成安裝，否則可能引起火災。
2. 若需用非常大的力氣將蝶翼板卡扣卡入集煙罩上的碰扣內，請參考 P17“安裝注意事項”中第 13 點檢查油煙機安裝面狀態，并按其提示進行操作。

安裝后的調試

- 輕觸電源 / 延時鍵，然後再輕觸高檔 / 超強檔鍵，檢測電機轉動是否正常，如出現下列異常情況，應立即切斷電源，停止運轉，並檢查是否為安裝緣故。
 - 機體震動劇烈
 - 葉輪不轉動
 - 葉輪轉動時明顯的摩擦聲
 - 電機出現異常聲響
- 按照操作說明，檢查所有按鍵功能是否正常。
(若確定吸油煙機發生故障，請致電方太授權的服務中心)

此產品的正確處置



此標記表示，在歐盟，此產品的處置不應與其他家庭垃圾一同進行。為防止未經控制的廢物處置可能對環境或人類健康造成危害，須對其進行可靠回收，以促進物質資源的可持續再利用。對使用過的設備進行退還，請使用回收系統，或聯系銷售該產品的零售商。此類人員可對此產品進行環保安全的回收利用。

爆炸圖

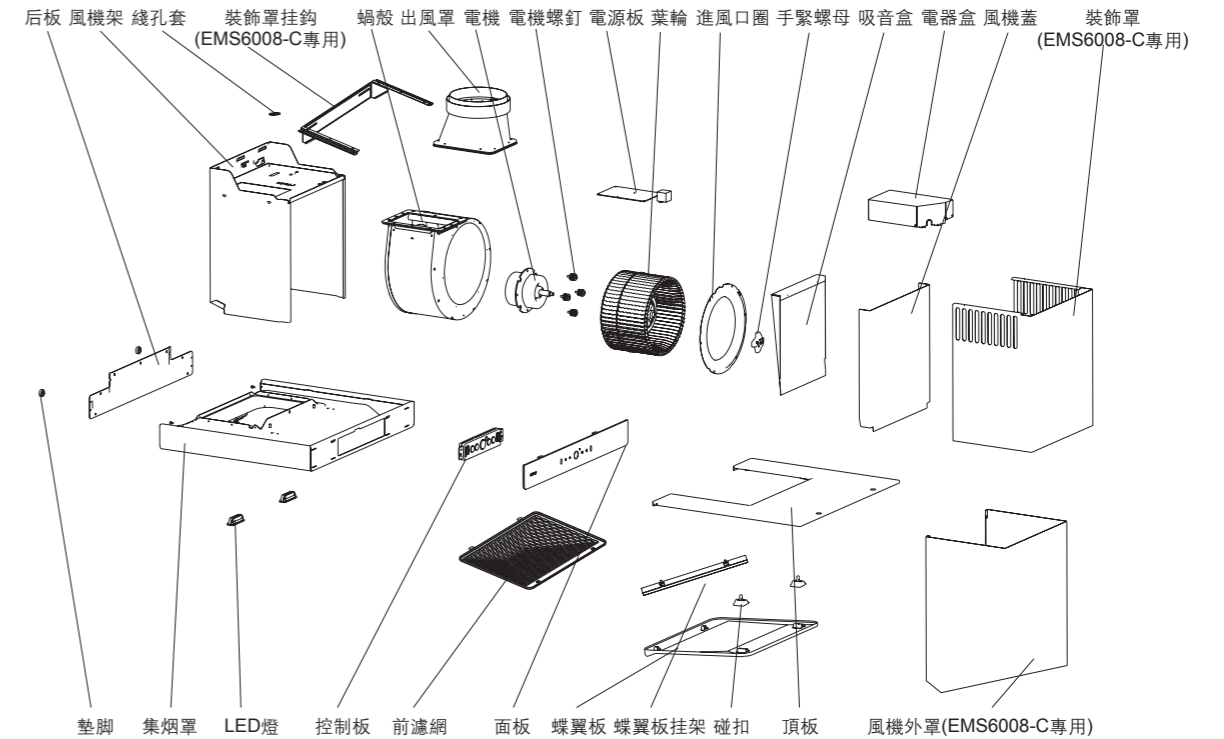



FOTILE

Range Hood

Operation and Installation Manual | EMS6008/EMS6008-C

Please read this product manual carefully before installation and use.
Please keep this product manual for future use.

Dear user, thank you for choosing the Fotile product range meticulously manufactured for you by Fotile. Please read through this Operation and Installation Manual before use (hereinafter referred to as the “manual”) to help you familiarize yourself with information concerning safety, operation, and maintenance of this range hood, and enable you to enjoy the new joy of cooking.

Please be sure to read this manual carefully before use, and follow the requirements set out in the manual during use. The operation instruction in this manual is very important for the product to be kept in a good working condition. In case of any product failure due to improper use, you will lose the right to free warranty, and any direct or indirect free warranty application will be rejected by our regional authorized service centers. In addition, it is important to both of us that you are suggested to contact Fotile’s local authorized service center when in need of maintenance during or after the warranty period.

Our authorized service center will provide you with professional spare parts and technical support of Fotile, so as to give high-quality and fast maintenance support to your product and offer you the most relaxing and attentive service.

If you need service, please provide the product model and serial number on the product nameplate. Refer to diagram A below to locate the nameplate on your product.

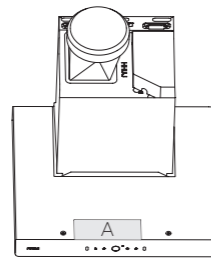

Aurora Trading Group Pty Ltd

* Address: 127/45 Gilby Road, Mount Waverley
VIC 3149

* Telephone: (03) 9939 9926

* Official Website: www.fotile.com.au

* Service Mailbox: service@fotile.com.au



FOTILE Australia official wechat

Contents

Warnings and Safety Instructions..... 2

 Installation 2

 Use.....2

 Don'ts 3

Product Information 5

 Product Specifications 5

 Product Performance 6

Method of Use 6

 Operation Instruction..... 6

Cleaning and Maintenance..... 8

 Surface Cleaning of the Appliance 8

 Cleaning the Wing Plate 8

 Cleaning of Oil filter 9

 Cleaning and Maintenance Cycle..... 9

Identification and Troubleshooting of Common Faults 10

 Troubleshooting of Common Faults 10

 Disclaimer..... 10

 Repair instructions..... 10

 Replacement of the LED Lamp.....11

Installation 12

 Assembly Height 12

 Fume Collection Rangs 14

 Packing List 15

 Precautions before Installation 16

 Installation of Exhaust Type Range Hood 18

 Installation of Inner Circulating Range Hood 24

 Commissioning after Installation..... 30





 Explosive View 31

Product features and parameters are subject to change at any time without notice and may differ slightly from this manual. Visit our official website at www.fotile.com.au for the latest information.

Warnings and Safety Instructions

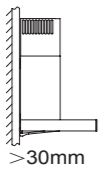

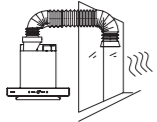
Installation



 Please follow the instructions below precisely

	As this range hood is heavy and has a complex installation procedure, its installation should be performed by installation and maintenance professionals according to the manual. Such dangers as electric shock, detachment or fire may be caused if installation of screws or fixtures is not completed in accordance with this manual.
	The wall on which the range hood is installed should have sufficient support strength. For hollow walls, the thickness of the solid layer of the hollow plate must be greater than 30 mm; for drywalls, the range hood shall be fixed onto the wooden pillar at the back; mounting holes can be drilled directly into concrete walls. The appliance must be firmly installed onto the wall.
	Be careful not to damage power cables or other hidden equipment such as gas or water pipes when cutting or drilling walls or ceilings.
	Make sure that the exhaust duct of the exhaust type range hood is connected to the outdoors to discharge the exhaust gas, so as to avoid fire hazard and ensure fresh air.
	To avoid electric shock, the range hood must be powered off before being moved for installation, cleaning or repairing. Be sure to wear protective gloves during installation, cleaning or repair to protect hands from being injured by the sharp edges of metal plates in the range hood.
	A separately controlled power socket is recommended for the range hood. If the range hood is to remain unused for a long time, please power it off.







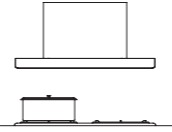

Use

 Please follow the instructions below precisely

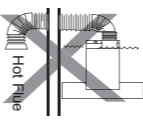
	Before using this product, please unpack it to check for damage. Do not install and use it in case of any obvious damage, and contact the Fotile authorized service center immediately.
	This product is for daily household use only. Do not use it for commercial purposes or in other special environments (e.g. outdoors); do not use it for discharging hazardous or explosive substances or gases. If this product is used in special circumstances, Fotile will assume no responsibility.
	When the range hood and gas stove are used at the same time, make sure that the doors and windows are not fully closed to guarantee a good air circulation in the room.

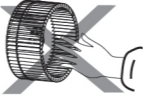
	Please follow the method specified in the manual to clean the range hood to avoid the risk of fire.
	To prevent oil overflow, it is recommended that the oil collection device is emptied weekly. Please do not reuse the waste oil collected in the oil collection device for cooking!
	Install the range hood directly above the stove and keep it horizontal.

Don'ts

	Do not modify, stretch, knot, or squeeze the power cable or put it under weight, otherwise accidents such as electric shock or fire may occur due to breakage of the power cable.
	Do not modify the internal wiring of the range hood without permission, otherwise human injury may be resulted from possible abnormal operation. Improper repair may lead to electric shock, fire or other dangers.
	Do not discharge the exhaust gas of the range hood into the hot flue used to discharge the smoke from burning gas or other fuels. The relevant air emission regulations must be complied with.
	Do not use the gas stove without cookware, otherwise the range hood above may get damaged.
	Do not touch the lamp bulb when it is turned on or has just been turned off, otherwise you may suffer burns.
	To avoid injury, do not put your hands or other articles into the rotating blades when the range hood is working.
	Electrical parts such as motor, switch and connector must not be damped by water. Do not clean the range hood with water. Do not use the range hood after it becomes wet as accidents such as electric leakage and electric shock may occur.
	Do not touch the power plug or electrical parts, or operate the power switch with wet hands as electric shock is likely to occur.
	The wall for installation shall be noncombustible. The range hood must not be installed on a flammable wall such as wooden wall.



- Reminders: a. Please wipe the outer surface of the range hood after each use.
 b. Frequently clean the outer surface of the range hood and oil collection device to ensure continued use of the product.







Safety

Caution: Accessible parts may become hot when used with cooking appliances.

Special Instructions: Please use the product in strict accordance with the regulations of this manual. Our company will assume no responsibility for any loss of property or personal damage caused by improper use of the product.

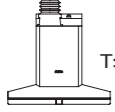
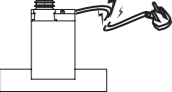
⚠ Warning: This product is not intended to be used by people with impaired physical, sensory or mental abilities, or a lack of experience or knowledge (including children), unless under the supervision or guidance of the person responsible for their safety.

⚠ Please follow the instructions below precisely

 ground connection	The plug must be inserted into a power socket which has been installed appropriately and grounded reliably to ensure safety. The grounding wire shall not be connected to a gas pipe, water pipe, lightning rod, telephone line, etc. Poor grounding may cause electric shock or other accidents.
 safety instruction	Please follow the safety guide of heating equipment manufacturer, and the safety standards issued by fire control and other administrative departments.
 NO OFF	If the cooking pan is on fire, turn off the range hood immediately (continued operation of the range hood will fuel the fire). Please extinguish the fire with effective methods; for example, cover the open flame with a metal lid, close the main gas valve immediately, and keep combustibles away from the flame.
 $T \leq 40^{\circ}\text{C}$	The temperature of the operating environment of the range hood shall not exceed 40°C .
	If the power cable becomes damaged, please contact the Fotile authorized service center for replacement to avoid danger.
 ON OFF	If anything abnormal occurs during operation, please turn off the power switch of the range hood, unplug the power plug, or cut off the main power, and call Fotile authorized service center immediately. Continuous operation in abnormal conditions may cause dangers such as electric shock or fire.
	Children are not allowed to use the range hood alone, or do not put the range hood in a place where the infant can reach it, otherwise burns, electric shock or other accidental injuries may occur.
 	To avoid risk of suffocation, children are not allowed to play with plastic packaging bags or boxes: keep the packaging away from children, as it is not a plaything. Children must be supervised strictly, to ensure that they do not play with the product.

Product Information

Product Specifications

The marked dimensions are for reference only (unit:mm)

EMS6008

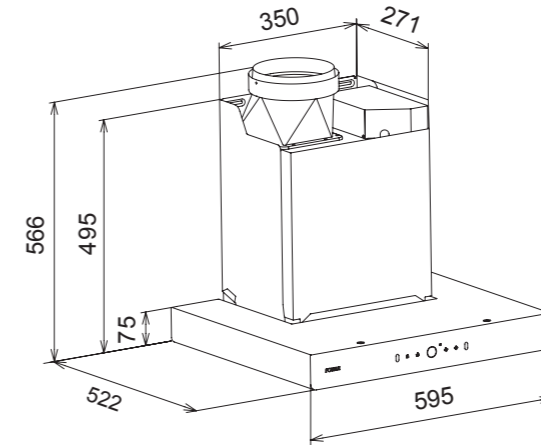

EMS6008-C

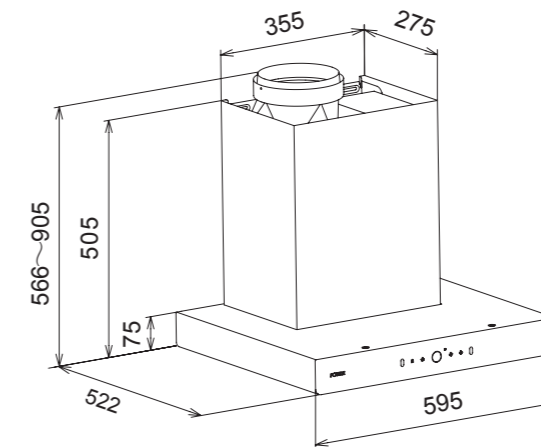

Product performance

Product model: EMS6008/EMS6008-C

Electrical parameters

Voltage/frequency	Motor power	LED lamp power	Total input power
220-240V/50Hz	294W	3W×2	300W

Performance parameter

Grease separation degree	96%	Odor reduction degree	99%	
Shift	Turbo mode	High mode	Middle mode	Low mode
Air volume (m ³ /h)	1180	1120	900	500
Noise (dB(A))	57	56	51	39
Maximum static pressure (Pa)	900			

- Notes:
- Air volume is tested in accordance with IEC 61591 standard, and noise tested in accordance with IEC 60704-3 standard.
 - The indicated noise value is A-weighted sound pressure level, and the sound power level are 69 dB(Turbo mode), 68 dB(High mode), 64 dB(Middle mode), 51 dB(Low mode);
 - Such parameters as air volume and noise may have a deviation of less than 5%.

Method of Use

Operation instruction

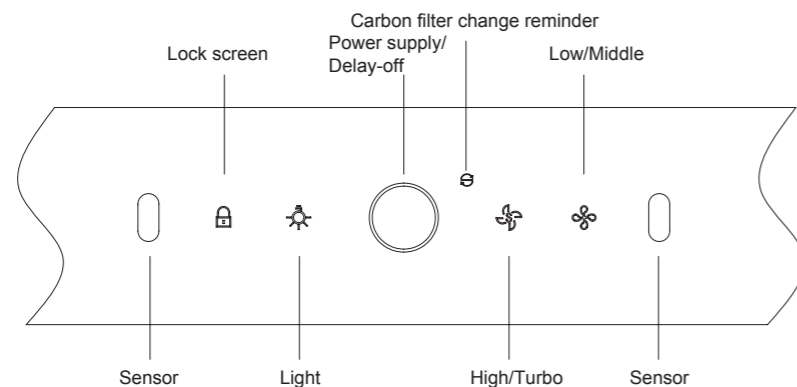

Gesture Function

In Off state, wave your hand and quickly pass by the induction windows on both ends of the operation panel. The range hood will start its high-speed operation and the LED lamp will be switched on. Wave your hand again and quickly pass by the induction windows on both ends of the operation panel, the power/delay indicator will flash and the range hood will be in the shutdown delay status. The LED lamp remains in its original state, and the light can be turned off by gently touching the lamp button. After operating for 1 minute in its current state, the fan will switch to low-speed operation and operate for 4 minutes before shutting down.

In Off state, press the lighting button and low-speed/middle-speed button simultaneously for 5 seconds, all the buttons on the control panel will be lit for 1 second and then go out, the gesture induction function is enabled/disabled.

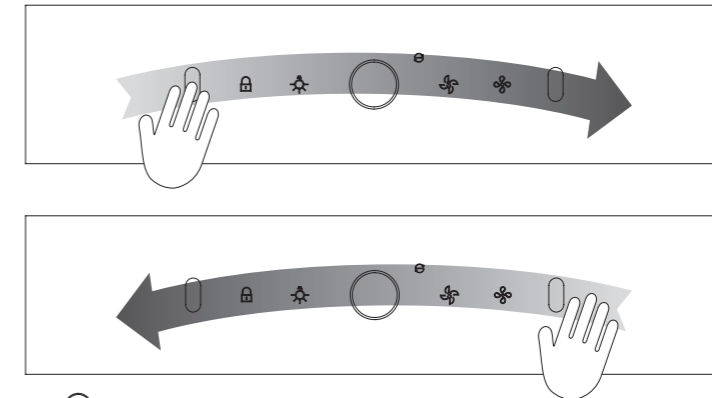

Power/Delay button

In Off state, gently touch the power/delay button once, the range hood will be in the standby state, the power/delay button indicator will be fully lit, and other button indicators will be slightly lit; in the operating state, gently touch the power/delay button, the power/delay button indicator will flash and the range hood will be in the shutdown delay state. The LED lamp remains in the original state, and the light can be turned off by gently touching the lamp button. After operating for 1 minute in the current state, the fan will switch to low-speed operation for 4 minutes before shutting down.

In the standby state or delayed shutdown state, gently touch the power/delay button once. All the button indicators will go out and the range hood will then be powered off.

All the following button commands will be carried out in standby mode:

High mode/Turbo mode

Gently touch the high mode/turbo mode. The high mode/turbo mode indicator will be half lit, and range hood will operate in high mode; gently touch the high mode/turbo mode again, the high mode/turbo mode indicator will be fully lit and flash, and the range hood will operate in turbo mode state. After 100 seconds, the range hood will return to high mode operation, and the high mode/turbo mode indicator will be half lit.

When the range hood is operating in turbo mode state, gently touch the high mode/turbo mode again, the high mode/turbo mode indicator will be lit slightly, and the range hood will stop operating.

Low mode/Middle mode button

Gently touch the low mode/middle mode button, the low mode/middle mode indicator will be half lit, and the range hood will operate in low mode state; gently touch the low mode/middle mode button again, the low mode/middle mode indicator will be fully lit, and the range hood will operate in middle mode state; gently touch the low mode/middle mode button again, the low mode/middle mode indicator will be lit slightly, and the range hood will stop operating.

Lighting button

Gently touch the lighting button, the button will be fully lit and the LED lamp will be turned on. Gently touch the lighting button again, the button will be lit slightly and the LED lamp will be switched off.







Lock screen button



When the range hood is not in operation, press the lock screen button for 2 seconds. After the machine makes a clicking sound, the indicator of lock screen button will be fully lit and flash, all buttons will be locked. The screen locking function can be cancelled by long pressing the lock screen button again for 2 seconds.

During operation of the range hood, the lock screen button is not active. If pressed, it will make a clicking sound.

Carbon filter change reminder

It is off by default, and it is only applicable to users who have separately purchased and installed the "carbon filter".

In Off state, simultaneously hold down the lighting button , high mode/turbo mode  and low mode/middle mode button  for 3 seconds. After hearing a clicking sound, the carbon filter change reminder lamp will be lit and then go out after 1 second. The carbon filter change reminder function is enabled. When this function is enabled, simultaneously holding down the lighting button , high mode /turbo mode  and low mode/middle mode button  for 3 seconds will disable the carbon filter change reminder function, and a clicking sound will be heard.

When the carbon filter change reminder lights up, please promptly change the carbon filter in the range hood. After completing the change in Off state, simultaneously hold down the lighting button  and high mode/turbo mode  for 3 seconds. After hearing the clicking sound, the carbon filter change reminder lamp will go out, and the change process is finished.



- Prompts :
1. The range hood will shut down automatically if it is not operated for two minutes;
 2. It is suggested to turn on the range hood when cooking to keep the kitchen air fresh, otherwise the gesture function may be triggered when more vapor passes by the induction window;
 3. For the specific change process of carbon filter, please refer to the following P9 "Operating Steps of carbon filter Change".

Cleaning and Maintenance

- Warning:**
1. There will be a risk of fire if the range hood is not cleaned as specified in this manual.
 2. To avoid electric shock, ensure the power cable is unplugged before cleaning and maintaining the range hood.
 3. Make sure that no water gets into the electrical parts such as the motor or control buttons during cleaning.
 4. Do not put your hand into the fan operating area during operation of the fan.
 5. Do not use such solvents as gasoline and benzene or such corrosive chemicals as strong alkali and strong acid for cleaning the range hood.

For better use, please clean the surface of the range hood, oil collection device and front filter assembly frequently. Frequent cleaning of the surface of the range hood, oil collection device and front filter assembly is beneficial to prolonging the service life of the range hood.

Surface Cleaning of the Appliance

Warning: When cleaning, please do not use such rough items such as cleaning balls, brushes or coarse cloth to protect the surface of machine body from scratches.

1. Clean with neutral soap or neutral detergent, and dry the surface of machine body with a soft cloth after cleaning.
2. Use neutral detergent to clean any stubborn dirt on the surface of range hood. Drop detergent onto the dirty area and leave it for a while, wipe off the dirt with a soft cloth, remove the detergent with a slightly damp towel, and then wipe the surface of the range.
3. Do not allow stains to remain on the surface of the range hood for too long.
4. If the stainless steel surface is accidentally stained with saline solution, disinfectant, bleaching powder or other detergents (most of the solvents contain harmful chemical components), immediately wipe it with wet cloth and then wipe it dry with a dry cloth.

Cleaning the Wing Plate

1. Grasp the front edge of wing plate with hands, pull it down to detach the locking tab of the wing plate (Fig. 1). Then flip it down at a certain angle, and remove the wing plate horizontally with hands finally (Fig. 2).
2. Soak the wing plate in warm water with neutral detergent, and wash it clean with soft brush or in the dishwasher.
3. Reinstall the wing plate after cleaning and wiping.

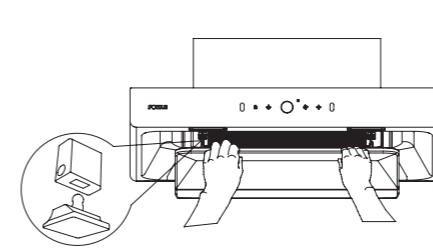

Fig.1

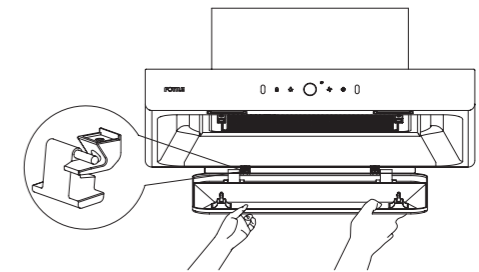

Fig.2

Cleaning of Oil filter

1. First remove the wing plate (see Fig. 1 and Fig. 2);
2. Remove the screw and oil filter (see Fig. 3 and Fig. 4);
3. Immerse the front filter in warm water with neutral detergent;
4. Reinstall oil filter and wing plate after cleaning and airing.

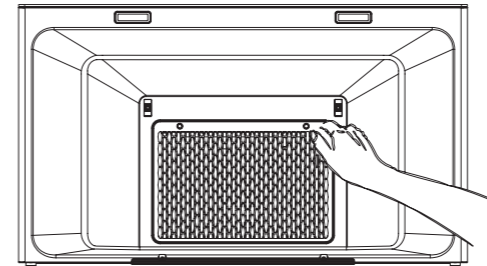

Fig.3

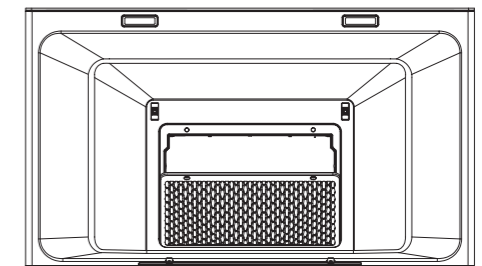

Fig.4

Cleaning and Maintenance Cycle

Parts to be cleaned	Recommended Cleaning (or Change) Cycle
Surface of the complete appliance	After each use
Wing plate	Clean weekly

Note: Please determine the specific cleaning period based on the actual cooking situation.

Identification and Troubleshooting of Common Faults

Troubleshooting of Common Faults

Fault Symptoms	Possible Reason	Repair Method
Range hood is not working and the LED lamp is not on	Not powered on	Check whether the power plug is properly plugged in
		Check whether the socket has power
Motor rotates but the LED lamp is not on	LED lamp damaged	Replace the LED lamp
Noise of mechanical vibration	Loose screws	Check whether the screws on the surface of the range hood are tight
Poor suction effect	Installation distance between the range hood and the stove surface is too large	Lower the installation height of the range hood (this operation must be carried out by a maintenance professional)
	There is too much ventilation and convection in the doors and windows around the range hood	Reduce ventilation or close some doors or windows
Gesture function does not work	Gesture function is off	Follow the operation on page P7 to restart the function

Disclaimer

- If the range hood still does not function normally after the above troubleshooting, please contact the Fotile authorized service center.
- Personnel from non-Fotile authorized service center are not allowed to repair the range hood to avoid serious consequences. Otherwise, the product will not enjoy warranty service.
- Free warranty will not be provided in the following circumstances:
 - Damage resulting from improper handling, installation, use, maintenance and safekeeping conducted by the customer.
 - Failure and damage caused by using the product beyond the normal operating conditions (damage caused in the case that the voltage is higher than 264V or lower than 206V)
 - The product installed, dismantled or repaired by customer or any party other than Fotile's authorized service staff or agency.
 - Discrepancy between the information on the purchase voucher and the warranty card and the product.
 - Product damage caused by a force majeure event (such as natural disaster and war, etc.)

Repair instructions

The following information is required:

- Date of purchase
- Product model
- Serial number (please see P2 for specific location)
- Relevant vouchers for purchase

Replacement of the LED Lamp

- Unplug the power plug of the range hood, or turn off the power of at the socket;

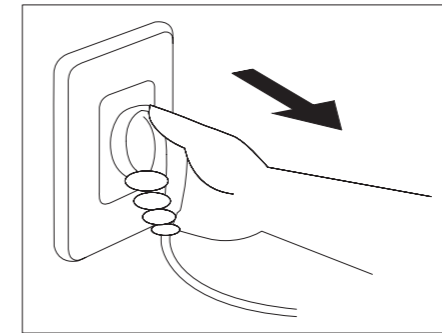

- Slightly insert a small blade-type screwdriver into the edge of the lamp, push down and remove the lamp assembly;

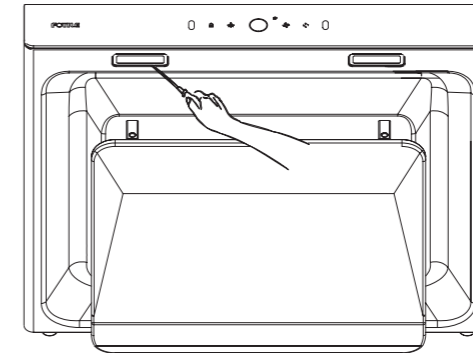

- Disconnect the lamp connection line and replace the whole LED lamp (The lamp wire should be assembled toward the wall).

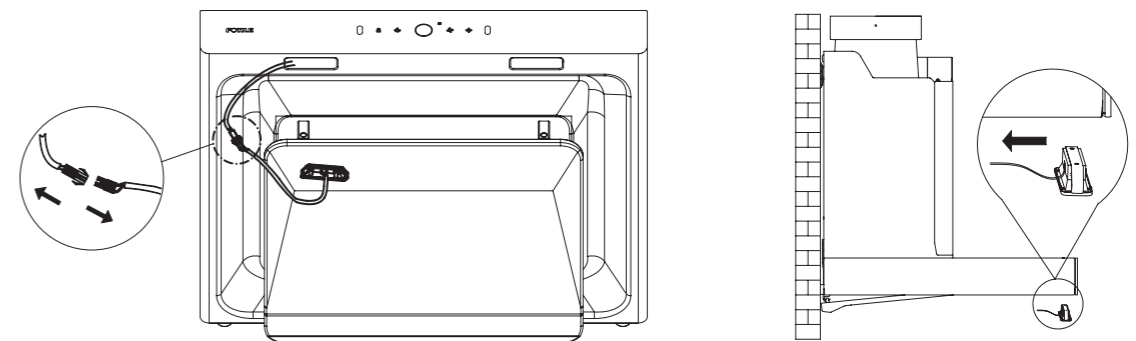

Danger of electric shock: Please unplug the power plug or cut off the power supply of the range hood socket before replacing the LED lamp to avoid electric shock.

Installation

Assembly Height

The marked dimensions are for reference only (unit: mm)
Installation diagram of Exhaust Type Range Hood

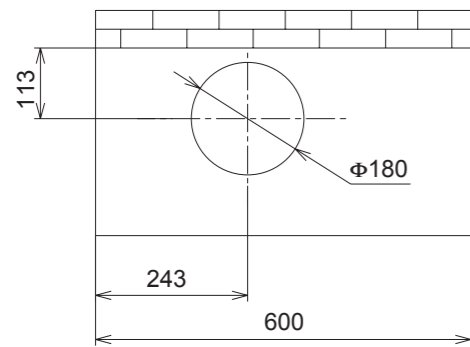

The hole size of the ceiling or cupboard top plate

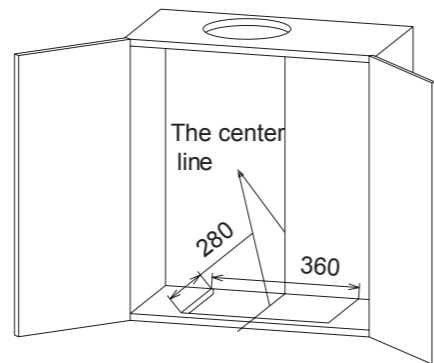

The hole size of the cabinet bottom plate

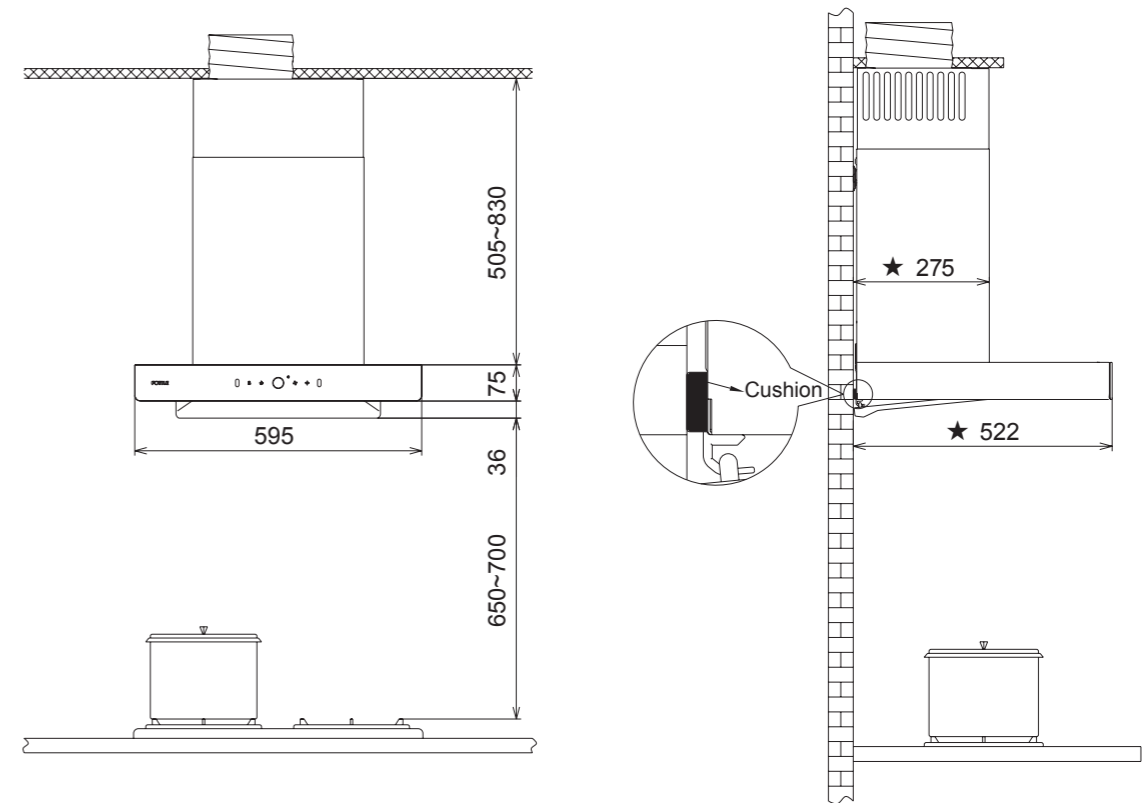

EMS6008-C Installation diagram (★ indicating the distance to the wall)

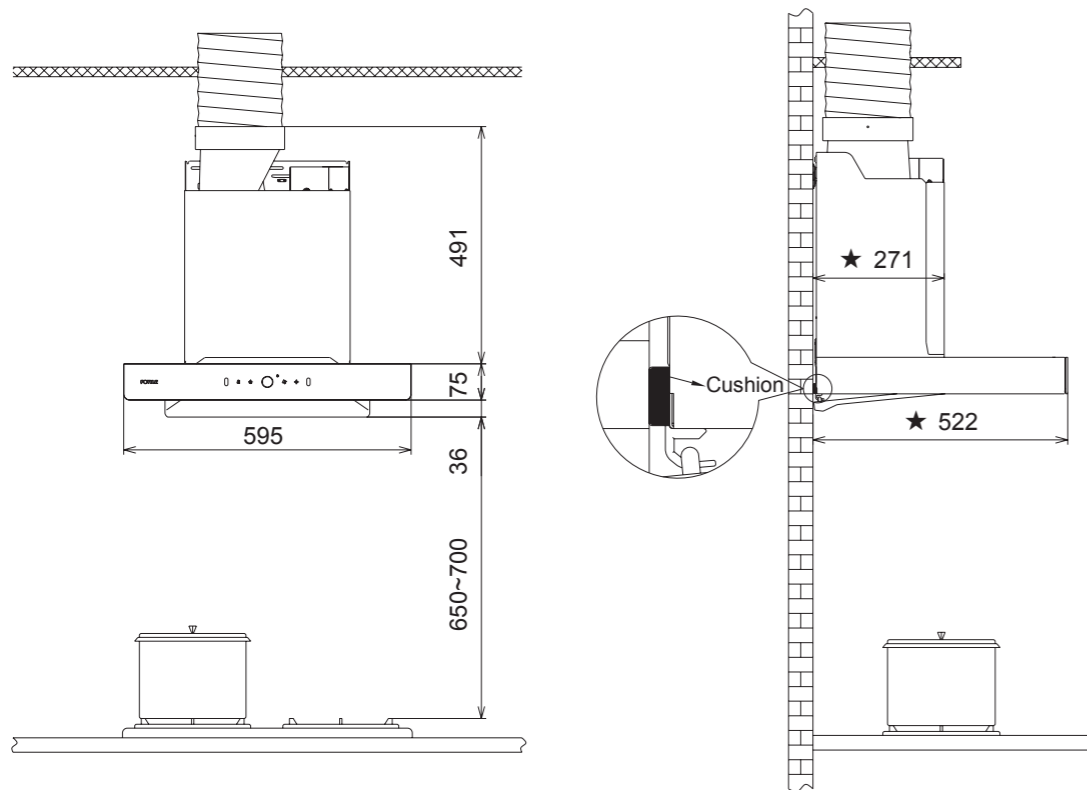



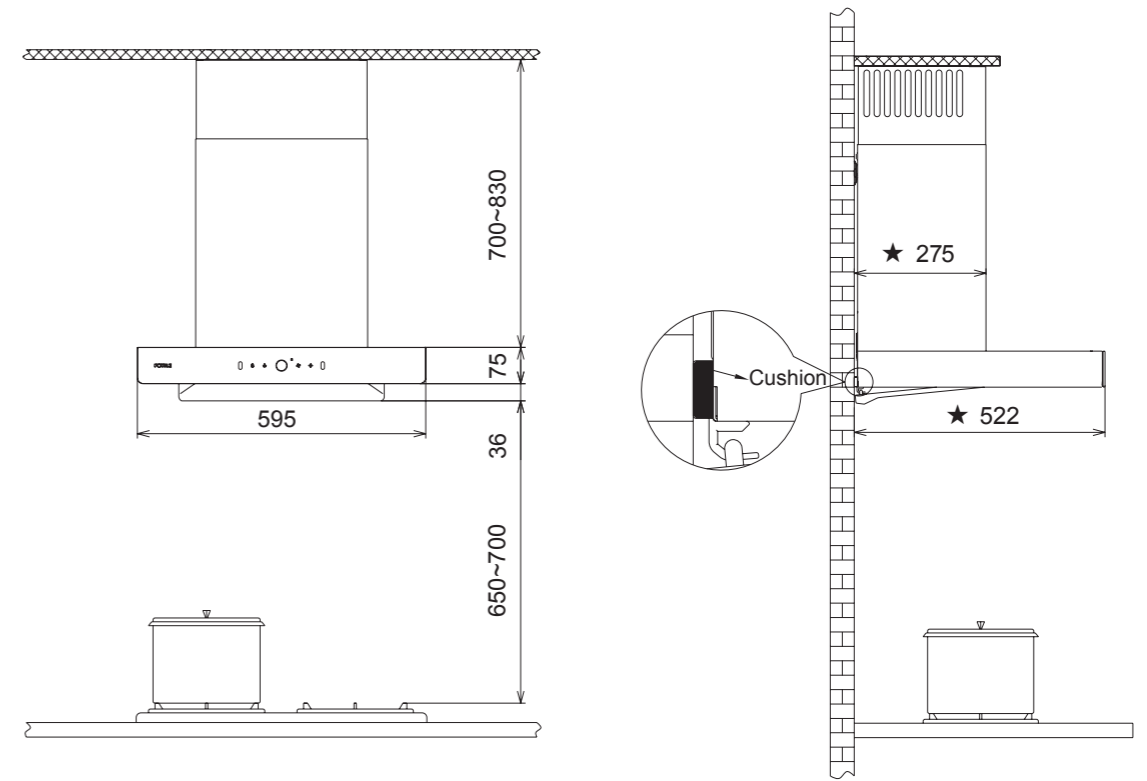







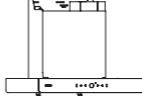

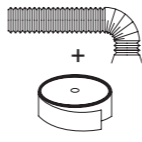
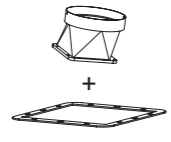
EMS6008 Installation diagram (★ indicating the distance to the wall)



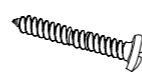
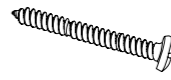
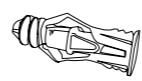
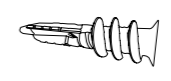
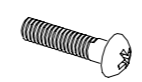

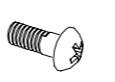
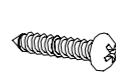
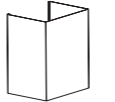
Installation diagram of Inner Circulating Type Range Hood (★ indicating the distance to the wall)

Note: 1.The installation height of the range hood is the recommended value (this height is the clearance value, i.e. the distance between the supporting surface of the cooking appliance on the stove and the lowest part of the range hood). The diagram of the collocation between the cupboard and the range hood is for reference only.
 2.Please pay attention to the clearance between the exhaust fume collecting hood of the range hood and the cupboard on both sides before installation or disassembly.
 3.If there is a relevant local law specifying the installation of range hood,it is suggested that you comply with such relevant laws. The suction effect might be influenced.

Packing List

	Main body (axonometric drawing)	1		Wing plate	1
	Exhaust duct	1		Outlet housing	1
	Sealing tape	1		Upper gasket	1
	Hook	1		Product instruction manual	1
	Warranty card	1		Adapter	1
	Hook screw ST4.2×36mm	7		Wood screw ST5×65mm	4
	Ceramic tile expansion tube φ5.3×32mm	7		Gypsum board expansion tube φ4×40mm	4
	Screw for outlet housing M4×18mm	8		Screw for exhaust duct ST3.9×9.5mm	4
	Screw for fan frame M4×6mm	2		Decorative cover screw ST2.9×19mm	2 (Only for EMS6008-C)
	Fan cover	1 (Only for EMS6008-C)		Decorative cover	1 (Only for EMS6008-C)
	Decorative cover hook	1 (Only for EMS6008-C)		Wing plate rack	1

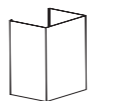
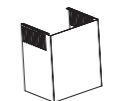
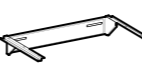
The following accessories must be purchased separately (please contact the authorized Fotile branch)

Cover accessories list					
	Fan cover	1		Decorative cover	1
	Decorative cover hook	1		Hook screw ST4.2×36mm	2



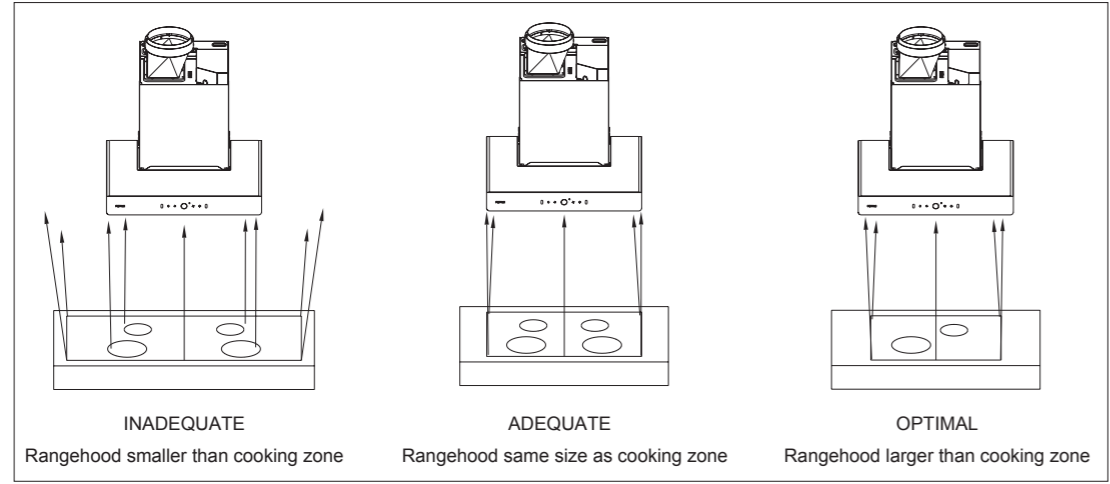

Fume Collection Range

Left and right fume collection range of the range hood

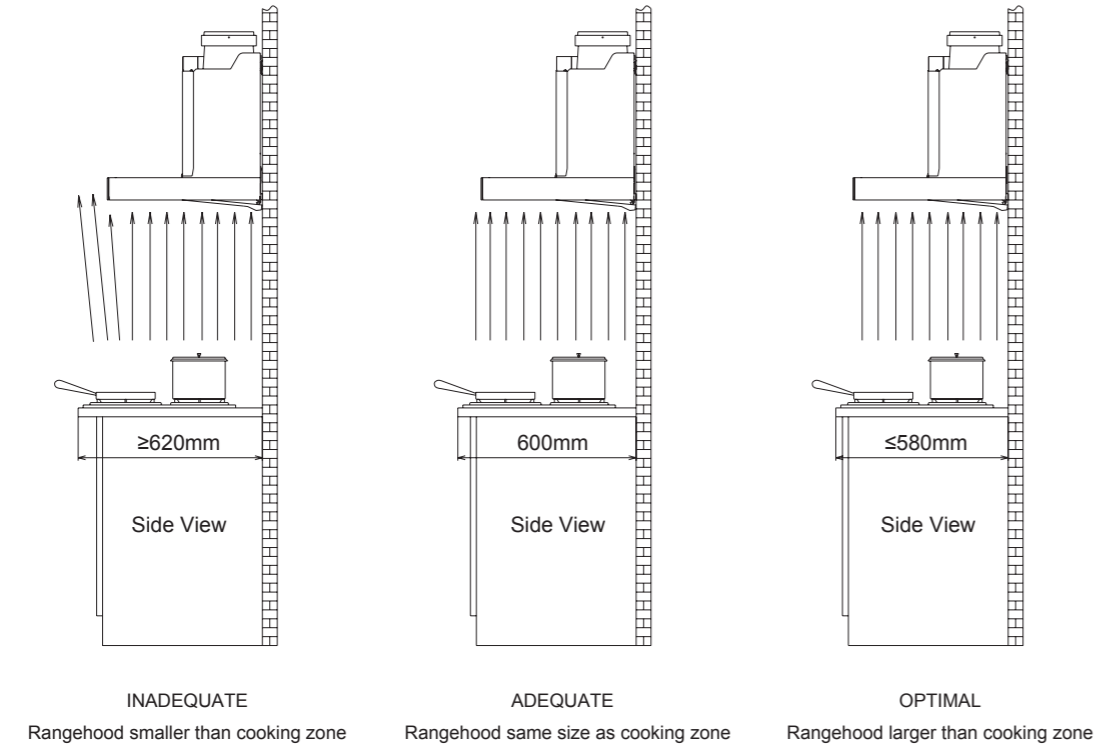

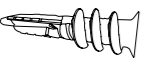
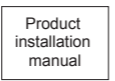
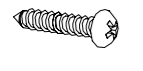
Front and rear fume collection range of the range hood

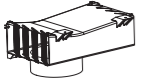
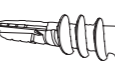
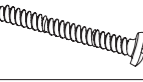
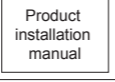
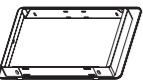

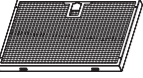
	Gypsum board expansion tube $\phi 4 \times 40\text{mm}$	2		Product installation manual	1
	Decorative cover screw ST2.9 \times 19mm	2		Foam cushion	4
Accessories for Recirculating System					
Wind-guide box accessories list					
	Wind-guide box	1		Gypsum board expansion tube $\phi 4 \times 40\text{mm}$	5
	Hook screw ST4.2 \times 36mm	5		Product installation manual	1
Carbon filter list					
	Connecting bracket	1		Cleaning the Front filter	1
	Carbon filter	1			

Precautions before Installation

■ Safety Precautions

☆ Special Note: In order to ensure the safe and correct use of this product, the installation and maintenance must be carried out by the service professionals authorized by Fotile. If the product does not function normally due to the installation or repair by customer or any party other than Fotile's authorized service staff, even during the warranty period, it is not within the scope of free warranty.

Please read all the instructions carefully prior to installation. Pay special attention to the following matters:

1. If you are decorating your kitchen, please do not leave the range hood exposed: the surface of the range hood will be corroded and lose luster due to building materials, dust, paint, coatings and the gases they volatilize. It is suggested to install the range hood after the kitchen is decorated.
2. As this range hood is heavy and has a complex installation procedure, it must be installed according to the instructions in the manual by installation and maintenance professionals authorized by Fotile.
3. When cleaning items around the range hood (such as suspended ceiling and cupboard) that may touch the range hood, please wear protective gloves and take other protective measures to prevent injuries or scratches.
4. Please be careful not to damage wires and other hidden equipment when drilling holes in the wall. The power supply cannot be switched on during installation, and the power should be turned off in the main power box.
5. A dedicated power socket which is reliably grounded must be used for the range hood. Electric shock, plug and socket heating and fire may easily occur when the power cable is connected in the middle, or if extension lines or multiport wiring devices are used. Please ensure that the operation is carried out by a professional electrician and in strict accordance with the power regulations of all applicable countries and regions: before wiring, please turn off the power supply and take reasonable measures to prevent the power supply from being automatically connected.
6. If the gas stove needs to be moved before installing the range hood, please close the main gas valve first.
7. The wall on which the range hood is installed should be sufficiently strong.
8. In order to ensure safety and smooth installation, during the installation of the expansion tube, there must be tight coordination between the expansion tube and the hole in the wall. It is strictly prohibited to drill

too much, so as to prevent the expansion tube from getting loose and accidentally falling.

9. To avoid fire hazards and keep the air fresh, the exhaust duct of the exhaust type range hood must be connected to the outdoor to discharge the exhaust gas.
10. It is not permitted for the exhaust gas discharged from the range hood to be discharged into the hot flue for burning gas or other fuel.
11. Try to ensure the fuselage remains horizontal during installation.
12. Confirm there are no abnormalities found in the trial operation upon installation. Please read the manual carefully and keep it for future reference.
13. Where there is a step difference on the installation wall of the range hood as shown in Fig.1, if there is a situation as shown in Fig.2, the operation shall be carried out as shown in Fig.3, i.e., the support plates shall be added on the back of the hook and the foot-pad of the range hood. The thickness of the support plates shall be consistent with the height of the steps.

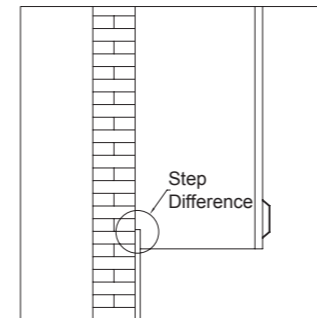

Fig. 1

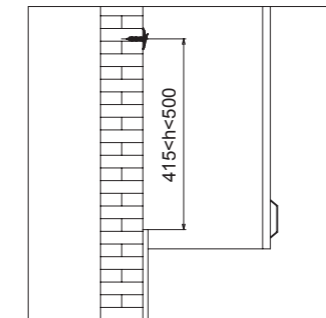

Fig. 2

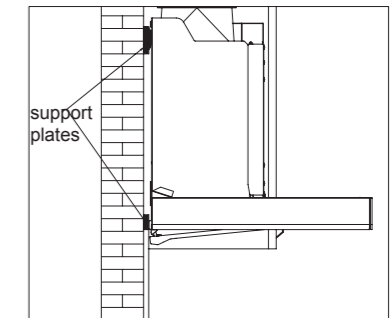

Fig. 3

■ Installation position

1. The range hood can only be installed in domestic kitchens, please do not use it in other situations.
2. The range hood must be installed above the stove, and the installation position is as shown in the installation diagram.
3. The temperature of the surrounding environment of the range hood cannot exceed 40°C.
4. The installation wall shall be noncombustible, and it is strictly forbidden to install on such flammable walls as those made of wooden wall.
5. Please follow the installation dimensions recommended in this manual to ensure the best oil fume suction effect.

■ Precautions before Installation

⚠ Warning: In order not to cause damage to the range hood, please make sure that no sundries enter the exhaust outlet.

1. To estimate the position of the exhaust duct from the range hood to the outside, refer to the installation diagram.
2. A straight short exhaust duct will make the smoke exhaust of the range hood more effective.
3. Try to avoid using an exhaust duct that is too long and has many bends, which will affect the smoke exhaust effect of the range hood.
4. The connection between the exhaust duct and the wall hole shall be tightly sealed with pipe adhesive tape. The exhaust duct must also be firmly connected to the exhaust hood.
5. If the hole in the wall is too small, the smoke exhaust effect shall be affected. To ensure safety, it is recommended the hole is expanded to the original size of the exhaust duct.

● Tool preparation

The following tools are required for installation of this range hood

- | | |
|--|--------------------------|
| (1) Electric impact drill (with drill $\phi 8$) | (2) Phillips screwdriver |
| (3) Wire pliers | (4) Tape measure |
| (5) Ribbon saw | (6) Level bar |

Installation of Exhaust Type Range Hood

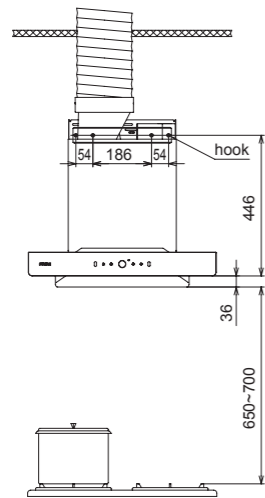

EMS6008 Installation dimension drawing (unit:mm)

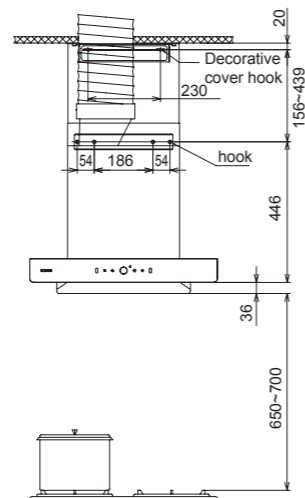

EMS6008-C Installation dimension drawing (unit:mm)

Warning: make sure operate with protective gloves.

1. Open the packing box and remove the main body. Check the packing list; (see P15)

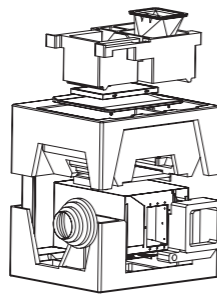

2. Remove the fan cover and decorative hood (only for EMS6008-C): remove the 2 screws that fix the fan cover behind the main body with a screwdriver(see Fig.6), and then grab the fan cover and decorative hood with both hands to take them out upward(see Fig.7);

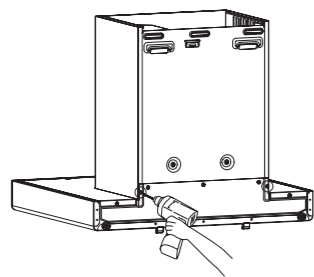

Fig.6

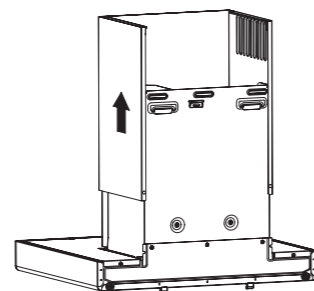
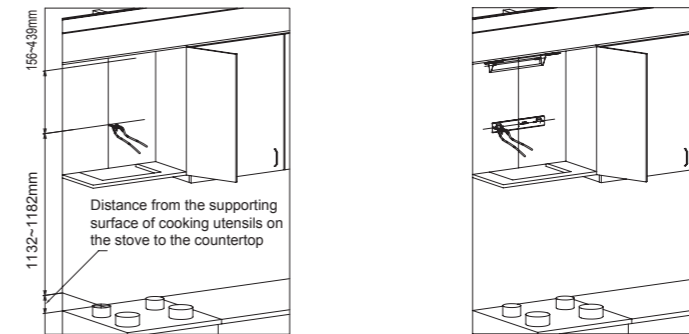

Fig.7

3. Confirm the position for fixing the hook: first, draw a vertical center line at the center point where the range hood is to be installed, then take the supporting surface of the cooking utensils on the stove as the reference point, accurately determine the installation position of the hook on the solid wall, and make a punch mark. The hook size of the main body is 1132mm-1182mm from the supporting surface of cooking utensils on the stove to the bolt hole of the hook; the hook size of the decorative hood (special for EMS6008-C) is 156mm-439mm from the bolt hole of the main body hook to the bolt hole of the cover hook ;



Notes: If ceramic tile, marble or glass and other decorative plates are found to protrude from the mounting surface of the hook, please refer to Point 13 of "Installation Precautions" in P17 for operation.

4. How to fix the hook: ;

- 1) Ceramic tile (marble) at the drilling mark: drill $\phi 8\text{mm}$ hole at the drilling mark with an electric drill, then embed the ceramic tile expansion tube ($5.3 \times 32\text{mm}$), fix the hook with the hook screw ($\text{ST}4.2 \times 36\text{mm}$), and use a spirit level to make sure the hook is level ;
- 2) Gypsum board at the drilling mark: screw the gypsum board expansion tube ($4 \times 40\text{mm}$) directly into the wall surface with a screwdriver at the drilling mark, then fix the hook with the hook screw ($\text{ST}4.2 \times 36\text{mm}$), and use a spirit level to make sure the hook is level ;

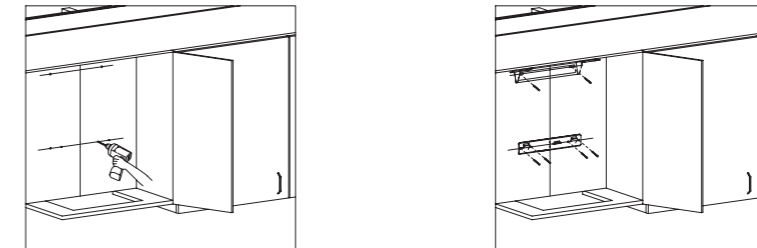

- 3) For the cover hook, two cover hook screws ($\text{ST}2.9 \times 19\text{mm}$) can be used to fix it to the ceiling.

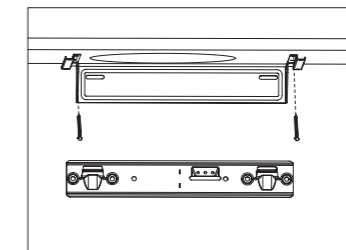

Notes: 1) The drill bit shall be selected according to the specific situation of the wall material at the installation site.

2) After cleaning with strong acid/alkali detergent or dish washing powder, it may cause the change of color of the front filter screen, but it does not affect the use.

5. Drilling the cupboard base board :First confirm the center line of the cupboard base board, then draw the drilling line according to the drilling size of the upper cupboard base board, and finally cut the hole in the cupboard base board along the drilling line with the wood cutting tool ;

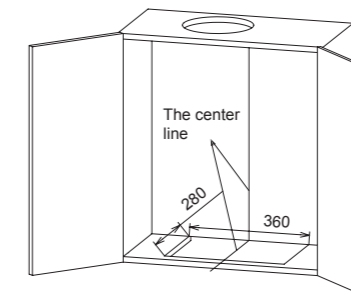

6. Installation of the exhaust duct: if the common flue interface or wall hole is larger than the diameter of the aluminum foil exhaust duct, the aluminum foil exhaust duct can be directly connected. If the common flue interface or wall hole is smaller than the diameter of the aluminum foil exhaust duct, the exhaust duct adapter shall be fitted on the end of the aluminum foil exhaust duct without plastic fixing ring, and shall be glued and sealed with adhesive tape. The small end of the exhaust duct adapter has two outer diameter specifications of 150mm and 125mm. Please cut off the excess part smaller than the common flue interface or wall hole according to the actual situation;

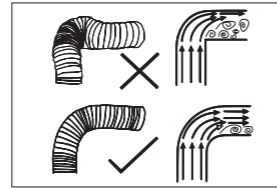
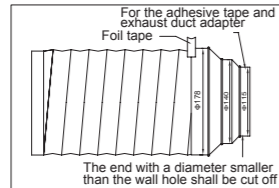

Notes: a. The joint between the exhaust duct and the common flue or the wall hole must be tightly sealed to prevent smoke leakage, and the exhaust duct should not be squeezed, deformed or turned at a small angle. The number of bending should no more than one, and the extraction hose should be straight;
 b. The diameter of the common flue interface or wall hole should be basically the same as the diameter of the exhaust duct and should not be too small, otherwise it will cause poor smoke exhaust, increased noise and reduced air volume.

7. Installation of the exhaust hood: fix the exhaust hood and sealing ring at the air outlet of the main body with 8 exhaust hood screws (M4 × 18 mm);

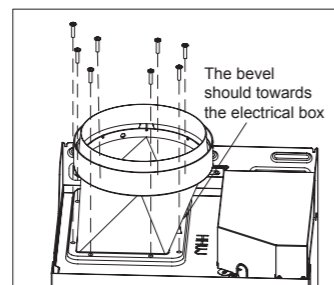

8. Remove the protective film from the top plate surface;

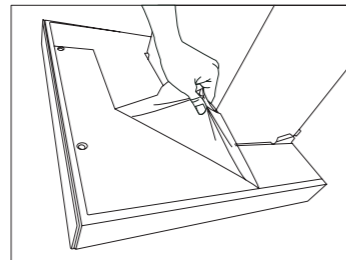

9. Lift the main body, let the fan frame pass through the cupboard bottom plate, hang the back hook hole onto the hook, confirm the level of the main body with a level bar, and fix the fan frame and the hook with the fan frame screw (M4 × 6mm);

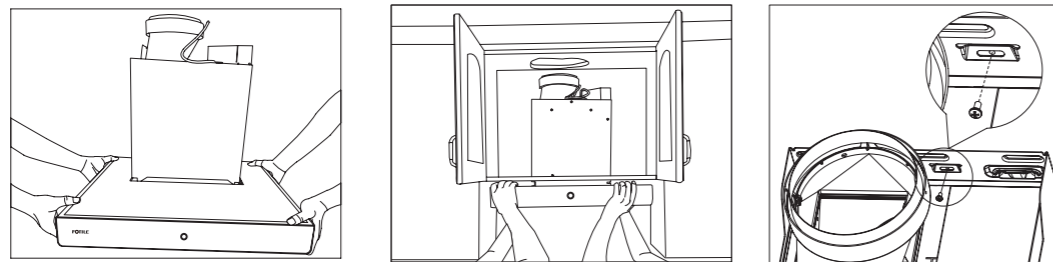

10. Connect and fix the exhaust duct: according to the actual installation position of the main body, cut off the redundant exhaust duct with wire pliers, then fix the exhaust duct on the exhaust hood with two exhaust duct screws (ST3.9x9.5), and wrap and seal with sealing tape;

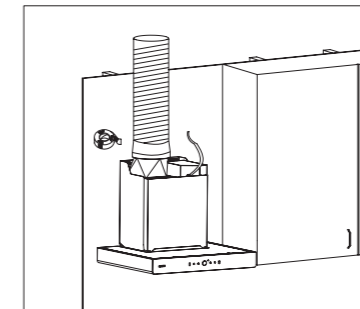

11. Insert the power plug of the main body into the power socket, start the range hood, and check whether the connection between the exhaust duct and the exhaust hood is sealed in good condition;

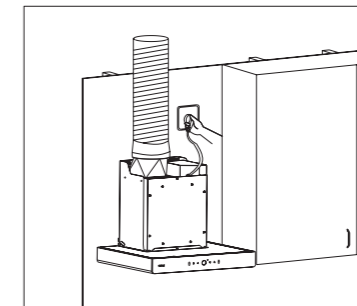

12. Installation of the fan cover and decorative hood (only for EMS6008-C);
 1) Remove the protective film from the surface of fan cover and decorative hood;

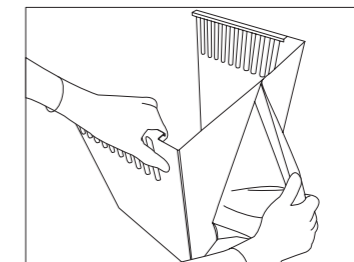
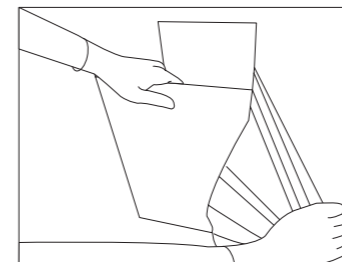

2) Put the decorative hood into the fan cover; ;

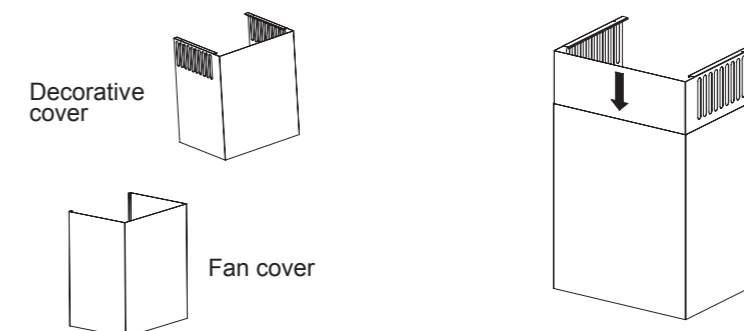

- 3) Take up the fan cover and the decorative hood at the same time, hang the decorative hood on the hook of the decorative hood first, and then simultaneously push the decorative hood and the fan cover to the end along the cover hook ;

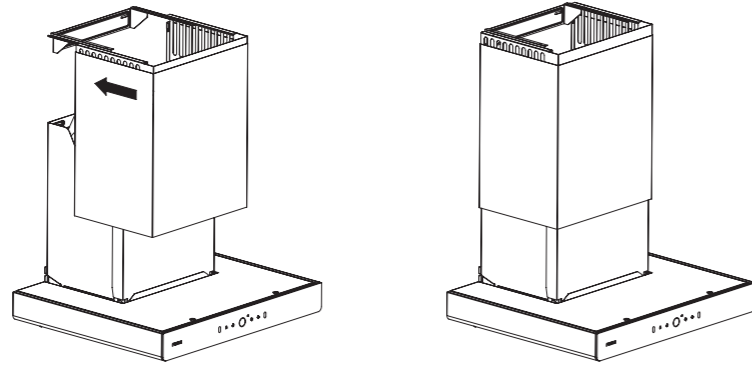

- 4) Slide the fan cover down slowly, clip the locking tab of the fan cover into the fan frame, and then insert the fan cover into the gap between the top plate and the fan frame.

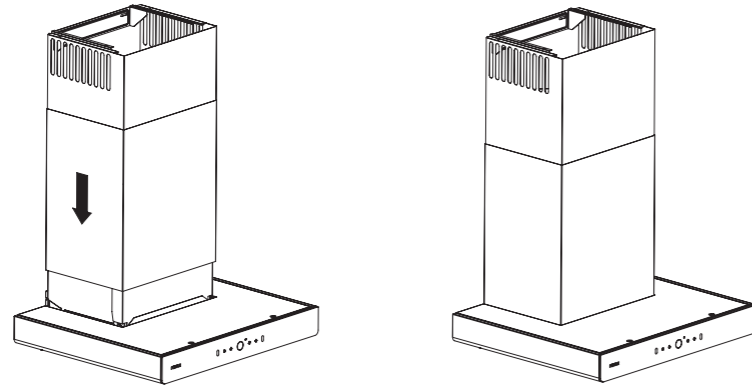

13. Installation the wing plate rack;

- 1) Remove the components of the rack;

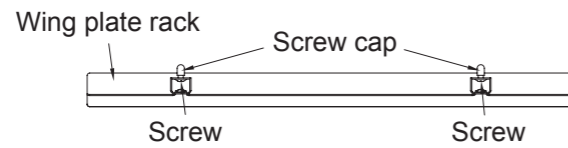

- 2) Remove the screw cap;

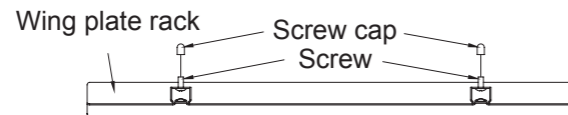

- 3) Fix the components of the rack to the bottom of the range hood with a cross screwdriver.

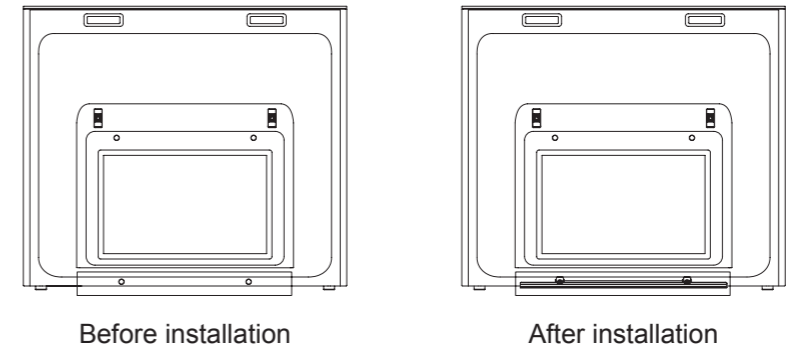

14. Installation of the wing plate;

- 1) Remove the protective film from the wing plate;

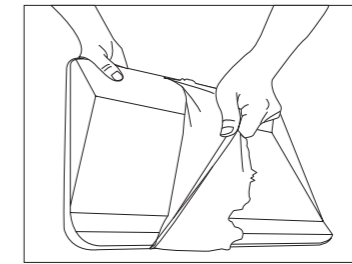

- 2) Hold the front side of the wing plate tightly with both hand, and putting the left and right hook on the rear side of the wing plate into the hook frame at the bottom of the exhaust fume collecting hood;

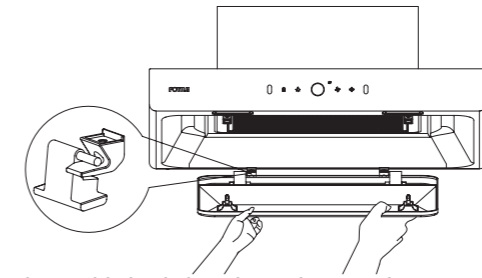

- 3) Hold the wing plate with both hands and rotate it upward, clamp the locking tab of the wing plate into the bump buckle on the exhaust fume collecting hood.

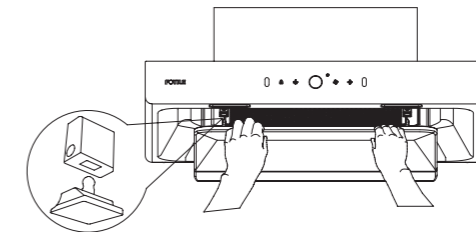

- Notes: 1. Failure to install all the parts (e.g. wing plate) in accordance with these instruction, may result fire hazard.
2. If it takes much effort to clip the locking tab of the wing plate into the buckle on the exhaust fume collecting hood, please refer to Point 13 of "Precautions for Installation" in P17 to check the status of installation surface for the range hood and operate according to the instructions.

Installation of Inner Circulating Type Range Hood

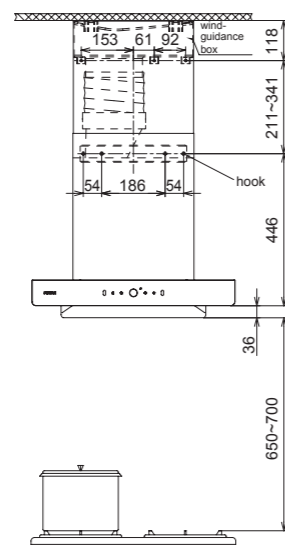

Warning: make sure operate with protective gloves.

1. Open the packing box and remove the main body, and check the packing list (see P15);

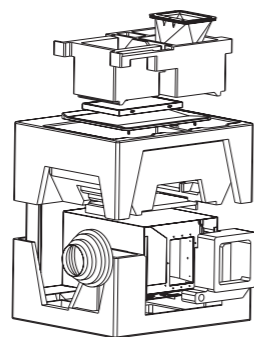

2. Remove the fan cover and decorative hood (only for EMS6008-C): remove the 2 screws that fix the fan cover behind the main body with a screwdriver(see Fig.8), and then grab the fan cover and decorative hood with both hands to take them out upward(see Fig.9);

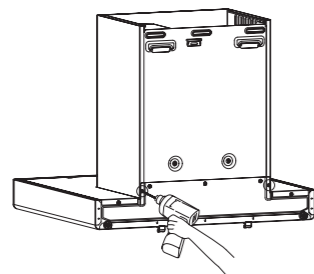

Fig.8

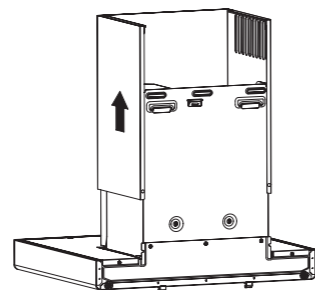
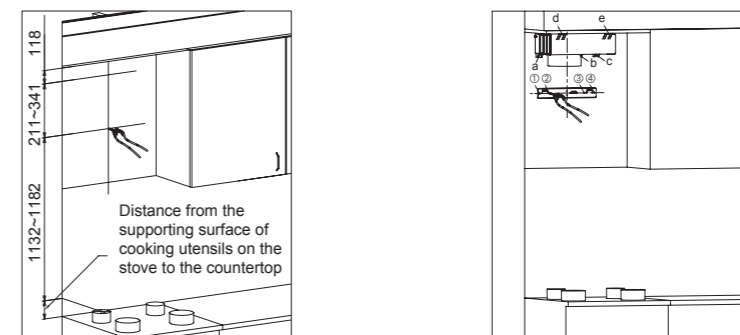

Fig.9

3. Confirm the position used to fix the hook of main body and wind-guide box: first, draw a vertical center line at the center point where the range hood to be installed, then take the supporting surface of the cooking utensils on the stove as the reference point, accurately determine the installation

position of the hook of main body and wind-guide box on the solid wall, and make a punch mark. The hook size of the main body is 1132mm-1182mm from the supporting surface of cooking utensils on the stove to the bolt hole of the hook.

The size of the wind-guide box: the top surface of the wind-guide box shall be installed close to the ceiling, the screw hole at the lower end of the wind-guide box shall be 118mm from the ceiling, and the screw hole from the screw hole of hook of main body to the screw hole at the lower end of the wind-guide box shall be ensured to be within the range of 211mm-341mm;



Note: If ceramic tile, marble or glass and other decorative plates are found to protrude from the mounting surface of the hook, please refer to Point 13 of "Installation Precautions" in P17 for operation.

4. Fix the exhaust duct on the wind-guide box with sealing tape;

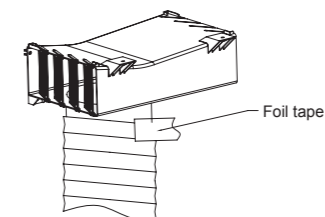

5. Fix the hook of main body:

- 1) Ceramic tile (marble) at the drilling mark: drill ϕ 8mm hole at the drilling mark with electric drill, then embed the ceramic tile expansion tube (5.3×32 mm), fix the hook with the hook screw (ST4.2 \times 36mm), and make sure the hook is level with a level bar.
- 2) Gypsum board at the drilling mark: screw the gypsum board expansion tube (4×40 mm) directly into the wall surface with a screwdriver at the drilling mark, then fix the hook with the hook screw (ST4.2 \times 36mm), and use a spirit level to make sure the hook is level.

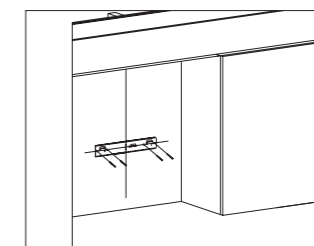
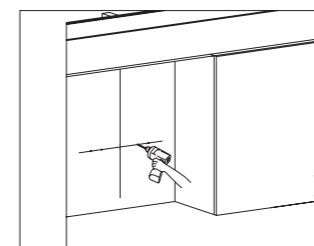

Note: After cleaning with strong acid/alkali detergent or dish washing powder, it may cause the change of color of the front filter screen, but it does not affect the use.

6. Fix the wind-guide box: directly screw the gypsum board expansion tube ($\phi 4 \times 40$ mm) into the wall surface with a screwdriver at the drilling mark (3 on the back wall and 2 on the ceiling), and then fix the wind-guide box with the hook screw (ST4.2 \times 36 mm);

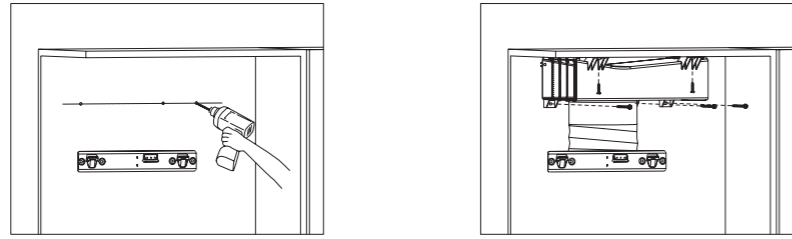

7. Install the exhaust hood: fix the exhaust hood and sealing ring at the air outlet of the main body with 8 exhaust hood screws (M4 × 18 mm);

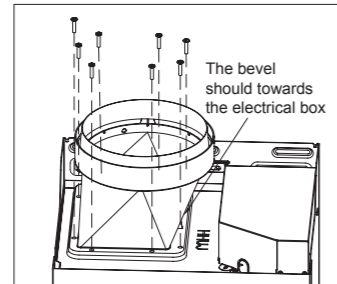

8. Remove the protective film from the top plate surface;

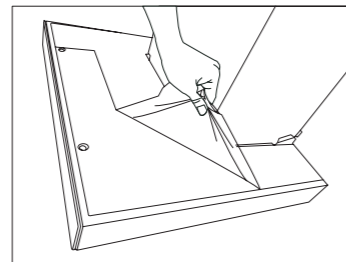

9. Lift the main body, hang the back hook hole onto the hook, confirm the level of the main body with a level bar, and fix the fan frame and the hook with the fan frame screw (M4 × 6mm);

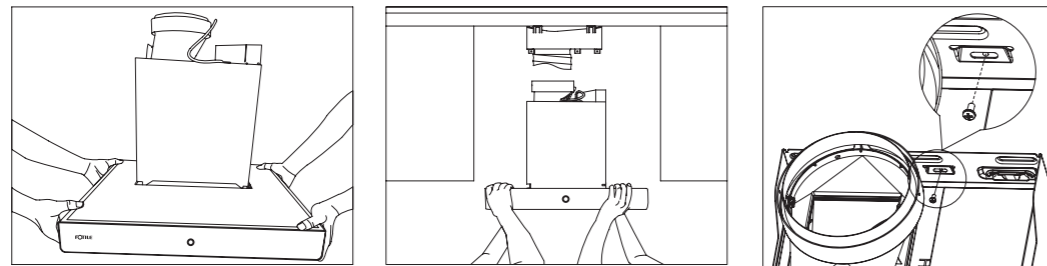

10. Connect and fix the exhaust duct: according to the actual installation position of the main body, cut off the redundant exhaust duct with wire pliers, then fix the exhaust duct on the exhaust hood with two exhaust duct screws ST3.9x9.5mm, and wrap and seal with sealing tape;

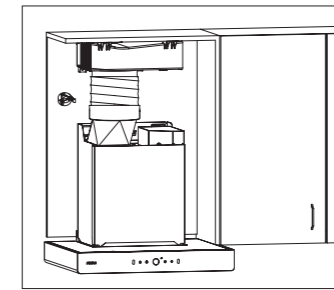

11. Insert the power plug of the main body into the power socket, start the range hood, and check whether the connection between the exhaust duct and the exhaust hood is sealed in good condition;

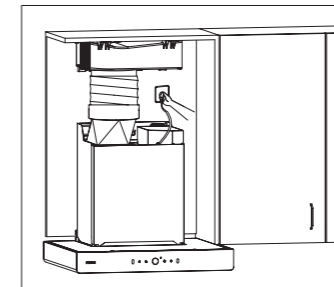

12. Install the fan cover and decorative hood :

1) Remove the protective film from the surface of fan cover and decorative hood;

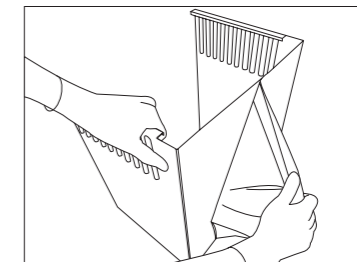
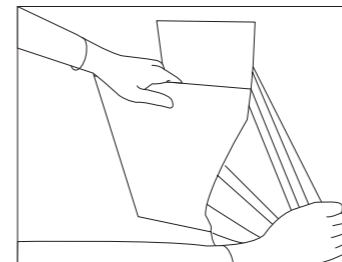

2) Put the decorative hood into the fan cover;

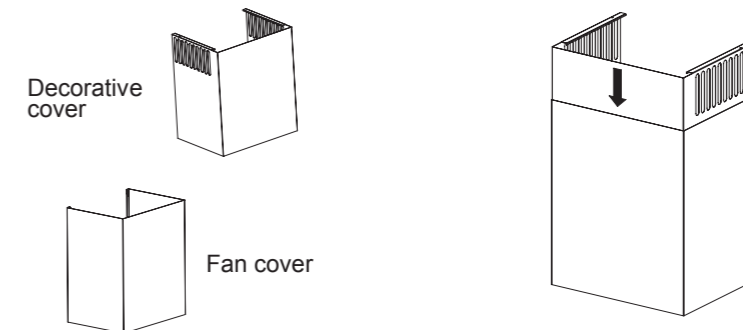

- 3) Take up the fan cover and the decorative hood at the same time, hang the decorative hood on the wind-guide box first, and then simultaneously push the decorative hood and the fan cover to the end along the wind-guide box;

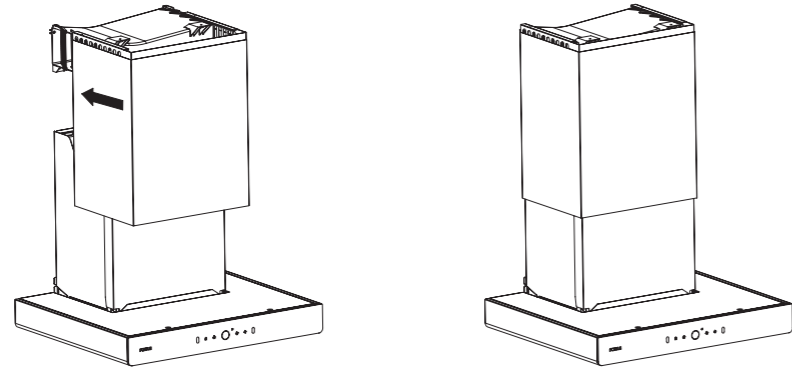

- 4) Slide the fan cover down slowly, clip the locking tab of the fan cover into the fan frame, and then insert the fan cover into the gap between the top plate and the fan frame.

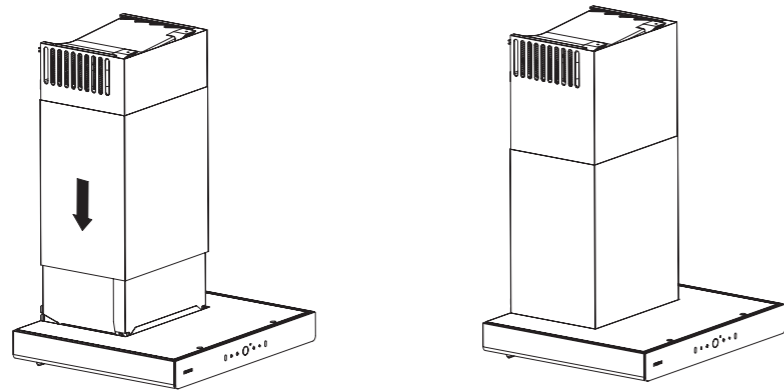

13. Install Carbon Filter:

- 1) First, detach the locking tab of the front filter directly, and remove the front filter;

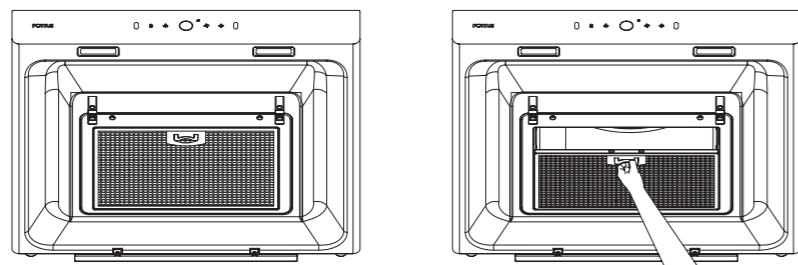

- 2) Install the carbon filter;

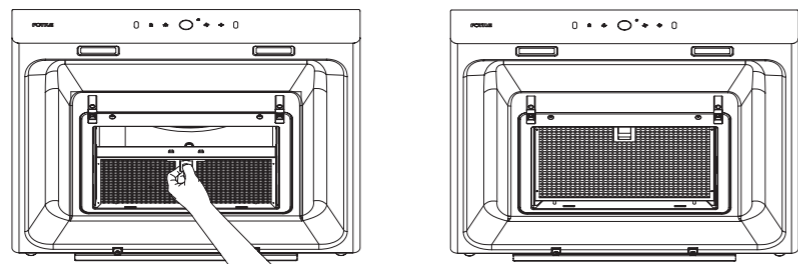

- 3) Finally, install the removed front filter in the original position.

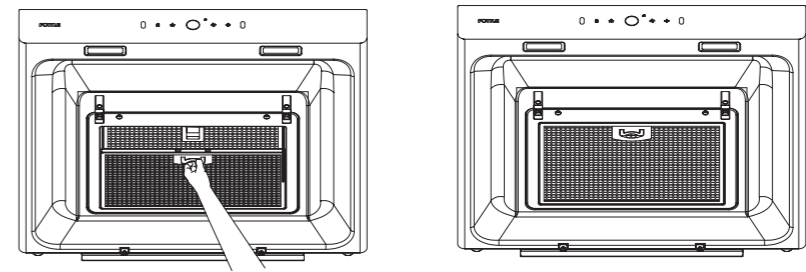

14. Installation the wing plate rack;

- 1) Remove the components of the rack;

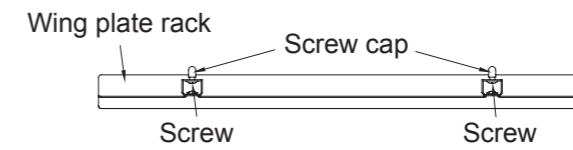

- 2) Remove the screw cap;

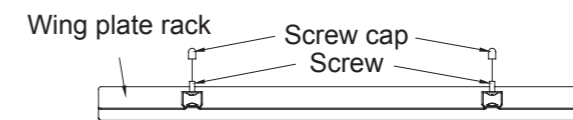

- 3) Fix the components of the rack to the bottom of the range hood with a cross screwdriver.

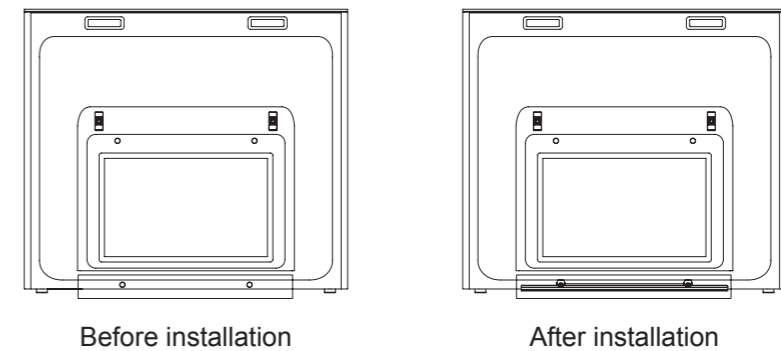

15. Install the wing plate;

- 1) Remove the protective film from the wing plate;

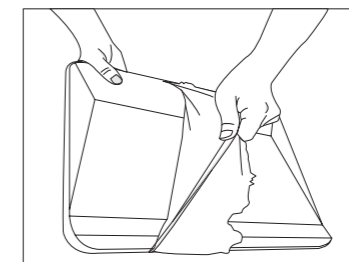

- 2) Hold the front side of the wing plate tightly in both hands, and put the left and right hook on the rear side of the wing plate into the hook frame at the bottom of the exhaust fume collecting hood;

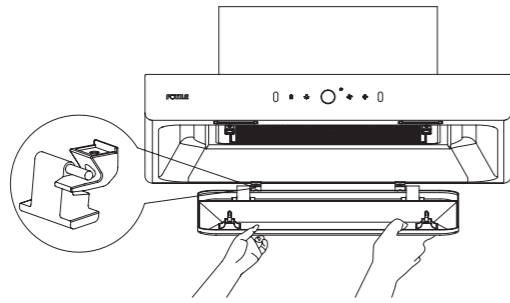

- 3) Hold the wing plate with both hands to rotate it upward, and then clamp the locking tab of the wing plate into the bump buckle on the exhaust fume collecting hood.

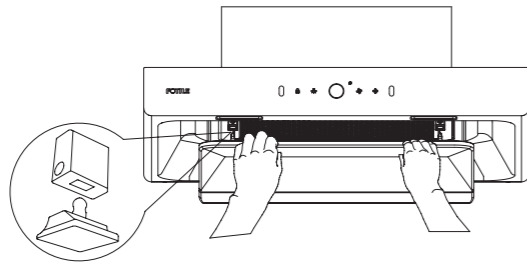

- Notes: 1. Failure to install all the parts (e.g. wing plate) in accordance with these instructions, may result in fire hazard.
2. If it takes much effort to clip the locking tab of the wing plate into the buckle on the exhaust fume collecting hood, please refer to Point 13 of "Precautions for Installation" in P17 to check the status of installation surface for the range hood and operate according to the instructions.

Commissioning after Installation

- Press the power/delay button, then press the high-speed /turbo button to check whether the motor rotates normally. In case of the following abnormal conditions, cut off the power supply immediately, stop the operation, and check whether this is due to installation:
 - The body vibrates violently
 - The blades not rotate
 - There is an obvious friction sound when the blades rotate
 - The motor makes an abnormal sound
- Check whether all buttons are functioning normally according to the operation instructions. (If it is determined that the range hood is faulty, please call the Fotile authorized service center)

Correct Disposal of this product



This marking indicates that this product should not be disposed with other household wastes throughout the EU. To prevent possible harm to the environment or human health from uncontrolled waste disposal, recycle it responsibly to promote the sustainable reuse of material resources. To return your used device, please use the return and collection systems or contact the retailer where the product was purchased. They can take this product for environmental safe recycling.

Explosive View

